

2814  
WASHINGTON, D. C.

# OPERATOR'S INSTRUCTION BOOK

APPLIES TO ENGINES WITH

BORE . . . . . 9"  
STROKE . . . . . 10½"  
NO. OF CYL. . . . . 4-5-6-8



INSTRUCTIONS NO. 18(s)

**Atlas Imperial Diesel Engine Co.**  
OAKLAND, CALIF. MATTOON, ILL.

J. W. CAMP  
4100 E. PRADO  
MIAMI 33, FLORIDA



OPERATOR'S  
**INSTRUCTION BOOK**

APPLIES TO ENGINES WITH

BORE . . . . . 9"  
STROKE . . . . . 10½"  
NO. OF CYL. . . . . 4-5-6-8



INSTRUCTIONS NO. 18(s)

CDR. ALBERT G. BEECHER (Ret.)  
2914 UPTON ST., N. W.  
WASHINGTON 8, D. C.

**Atlas Imperial Diesel Engine Co.**  
OAKLAND, CALIF. MATTOON, ILL.



TABLE OF CONTENTS

The material in the Instructions has been arranged in sections each dealing with a specific subject or subdivision of the engine. The sections are arranged alphabetically and the Titles and main contents are listed below.

	<u>Section</u>	<u>Page In Section</u>
GENERAL ENGINE DATA-----	A	
FUEL AND LUBRICATING OILS-----	B	
INSTALLATION INSTRUCTIONS-----	C	
OPERATING INSTRUCTIONS-----	D	
Starting the Engine-----		1
Running and Stopping the Engine-----		2
LOWER BASE, CRANKSHAFT AND BEARINGS-----	F	
Main Bearings-----		1
Crankshaft Alignment-----		2
CENTERFRAME - CYLINDER BLOCK AND LINER - CYL- INDER HEAD AND VALVES-----	H	
Cylinder Block and Liner-----		1
Cylinder Head and Valves-----		1
Starting Air Valve-----		2
Compression Release and Safety Valves-----		2
PISTON AND CONNECTING ROD-----	K	
Connecting Rod Bearings-----		2
CAMSHAFT AND VALVE OPERATING GEAR-----	L	
Camshaft, Camshaft Removal and Disassembly---		1
Camshaft Assembly, Lifters and Push Rods-----		2
Valve Timing Table, Flywheel Markings-----		4
Inlet & Exhaust Valve Timing-----		4
Starting Air Valve Timing-----		4
FUEL SUPPLY SYSTEM-----	N	
Fuel Transfer Pump-----		1
Day Tank and Filter-----		2
FUEL INJECTION SYSTEM-----	O	
High Pressure Fuel Pump-----		1
Accumulator and Tubing-----		3
Fuel Pressure Regulating Valve-----		3
Spray Valves-----		4
Spray Valve Servicing-----		6
Spray Valve Operating Mechanism-----		8
Spray Valve Timing-----		9
Balancing Engine for Cyl. Load Distribution--		9
GOVERNOR-----	Q	
Atlas Standard Governor-----		1
Woodward Governor and Drive-----		2
Overspeed Governor-----		3
LUBRICATING OIL SYSTEM-----	T	
Lubricating Oil Pump-----		1
Oil Cooler-----		2
Strainer-----		3
Lubricator and Drive-----		4
MAINTENANCE AND INSPECTION-----	Z	
Smoky Exhaust-----		1
Maintenance Routine-----		2

TC7 - Ed 1-1



GENERAL ENGINE DATA

The Atlas Imperial Diesel Engine described herein is of the heavy duty, solid injection, full Diesel type, designed especially for reliability and a long life of trouble-free operation. It operates on the four stroke cycle, the sequence of operation being as follows:

- 1st Stroke On the downward or suction stroke of the piston, the inlet valve is open and pure air is drawn into the cylinder through the air inlet manifold.
- 2nd Stroke On the second or compression stroke, this air is compressed to about 400 lbs. per square inch, the heat of compression raising the air temperature to a point above the ignition temperature of the fuel. Just before the piston reaches top center, the injection is completed shortly after the piston has passed the top dead center.
- 3rd Stroke On the power stroke the injected fuel oil burns, increasing the pressure within the cylinder, and driving the piston down through its working stroke. Shortly before bottom center position is reached, the exhaust valve opens.
- 4th Stroke As the piston returns toward the head, the burned gases are discharged through the exhaust valve, and as the piston reaches top center the exhaust valve is closed, the inlet valve is opened, and the cycle is repeated.

The 9" x 10 $\frac{1}{2}$ " bore and stroke engines are built in 4, 5, 6 and 8 cylinder models. The horsepower rating and the rated speed of the engines are stamped on the engine nameplate and these ratings should never be exceeded.

On the nameplate will also be found the engine serial number which should always be stated when ordering parts and in any correspondence with the factory or Sales agencies. The firing order, valve timing and the model designation will also be found on the engine nameplate. When corresponding or ordering parts it is desirable that the model number be stated also. The engine serial number is, however, more important and if the model number is not known the number of cylinders and the bore and stroke of the engine may be stated.

The number of orifices, the orifice diameter and the angle of the orifices in the spray valve tip are also stamped on the engine nameplate. The number of holes or orifices is stamped first, followed by the diameter of the holes in thousandths and in turn followed by the hole angle in degrees. For example, 5-10-20 indicates a spray valve tip which has five holes or orifices of .010" diameter. The axis of the holes or orifices are inclined 20° with the horizontal. If ordering spray valve tips the stamping on the nameplate should be stated.



## Section A

The following data apply to all 9" x 10½" bore and stroke engines.

### PRESSURES:

Lubricating Oil Pressure -----40 to 50 lbs./Sq.In.  
Fuel Oil (at transfer pump discharge)-10 lbs./Sq.In. MAX.  
Fuel Oil (in rail)-----1500 to 5000 lbs./Sq.In.  
Starting Air Pressure-----125 to 250 lbs./Sq.In.

### TEMPERATURES:

Cooling Water - Engine Outlet-----160° F. Max.  
Lubricating Oil - Cooler Outlet-----140° F. Max.  
Exhaust Temperature (At full load, full speed)---730° F. Max.

### DATA FOR ATTACHED AUXILIARIES:

#### 4, 5, 6 AND 8 CYLINDER ENGINES

High Pressure Fuel Pump - Single Acting  
Bore-----1/2"  
Stroke-----1"  
No. of Cylinders-----2  
Operating Speed-----.832 x Engine R.P.M.

Fuel Transfer Pump - Internal Gear Type - Tuthill Pump Co.  
Model 2CS  
Capacity (514 Engine R.P.M.)4.2 G.P.M.

#### 4, 5 & 6 CYLINDER ENGINES

Lubricating Oil Pressure Pump - Internal Gear Type  
Tuthill Pump Co. Model 4CSA  
Capacity (514 Engine R.P.M.)10.3 G.P.M.

Lubricating Oil Sump Pump (If Used) - Internal Gear Type  
Tuthill Pump Co. Model 4CSA  
Capacity (514 Engine R.P.M.)15.4 G.P.M.

#### 8 CYLINDER ENGINES

Lubricating Oil Pressure Pump - Internal Gear Type  
Tuthill Pump Co. Model 5CSA  
Capacity (514 Engine R.P.M.)17.6 G.P.M.

Lubricating Oil Sump Pump (If Used) - Internal Gear Type  
Tuthill Pump Co. Model 5CSA  
Capacity (514 Engine R.P.M.)25.7 G.P.M.



FUEL AND LUBRICATING OILS1. RECOMMENDED FUEL OIL SPECIFICATION

Viscosity - - - - -	35 to 70 S.U. Seconds at 100° F.
Gravity (A.P.I.)- - - - -	Minimum 24°
Conradson Carbon (A.S.T.M.-D189)-	Maximum 0.5%
Ash - - - - -	Maximum 0.05%
B.S.&W. - - - - -	Maximum 0.1%
Sulphur (A.S.T.M.-D129) - - - - -	Maximum 1.0%
Ignition Quality- - - - -	40 to 60 Cetane Number or equivalent in other ignition index.

2. EFFECT OF FUEL PROPERTIES ON PERFORMANCE

As adjusted at the factory the engine will operate satisfactorily on fuels with viscosities per above specification. It is possible to use thinner fuels but the operation is apt to be "snappy" and it may be difficult to maintain even cylinder load balance at varying loads. Fuels with viscosities less than 35 S.U.S. may also require special spray tips with smaller orifice holes than standard or the fuel pressure may have to be reduced. On the other hand fuels with high viscosities may require larger spray orifices than standard, increased fuel pressure and in extreme cases longer period of injection. To insure good operation it is recommended that the viscosity be held to the specification.

The gravity is of secondary importance. A minimum of 24° A.P.I. is merely given since heavier fuels generally require special treatment, such as heating and centrifuging, before they can be burned successfully.

The "Conradson Carbon" or "Carbon Residue" in the oil is an index to the amount of carbon which will form in the combustion chamber. Fuels with high "Conradson Carbon" may cause carbon to build up on the spray valve tips to such an extent that the fuel sprays are deflected causing poor operation and smoky exhaust. The higher the Conradson Carbon the more frequently will it be necessary to clean the spray valve tips. Experience also indicates that maintenance costs will be higher when fuels with high "Carbon Residues" are used.

The Ash content of a fuel is a measure of the amount of mineral material it contains. After burning the mineral residues are abrasive and it is consequently important that the Ash content be limited to 0.05%. If the content is higher rapid wear of cylinder liners, pistons and rings will result.

The item B.S.&W. (Bottom Sediment and Water) is an index to the fuel's cleanliness. It is good economy to use clean fuel and store it in clean tanks. Cleanliness in handling the fuel is also important (See paragraph entitled "Importance of Cleanliness in Fuel Handling" in Section N).

When the fuel oil is consumed in the engine Sulphur burns to Sulphur-dioxide. Under normal operating conditions most of this gas is ejected with the exhaust gases. If, however, temperature conditions are low enough, that is, if the engine is idling at low speed and under cold conditions, the sulphur-dioxide gas combines with condensed water vapors to form a corrosive acid which will attack metals used in the engine and exhaust system. It is consequently particularly important to hold the sulphur content low in fuels used for engines subject to variable loads with long periods of idling and also for engines subject to frequent starting and stopping.

The Cetane number of a fuel is an index of the ignition quality. Low Cetane values produce excessive knocking. Excessively high Cetane fuels cause high exhaust temperatures and smokiness of the exhaust.

Although the Flash Point does not affect the suitability of a diesel fuel it is well to specify a minimum of 150° F. since state laws and Classification Societies generally require this minimum. The Pour Point of the fuel should be at least 15° F. below the lowest temperature to which the fuel storage tank is subjected.

3. LUBRICATING OIL

We recommend that a good grade of pure mineral oil be used in these engines. The oil should be stable under the temperature conditions encountered in the engine and should be resistant to oxidation and sludging. In general, regarding quality of lubricating oil we refer you to a Lubrication Instruction Book which will be sent to any customer or operator requesting it. This book contains some good pointers on the selection and care of lubricating oils.



## Section B

It is not necessary to use compounded oils, i.e., oils containing additives, inhibitors, anti-oxidants, carbon removers, etc. in Atlas Engines. There are, however, many good compounded oils on the market and these may be used providing extreme caution is exercised and the action of the oil in the engine is observed closely.

When a pure or "straight" mineral oil is used some carbon or other deposits will generally be found in the crankcase and sump tank. The amount of these deposits depend greatly on the quality of the oil which has been used and for good grades of oil the deposits are not excessive and in any way harmful to the engine. The chemicals contained in the compounded oils enable these oils to carry the carbon and other constituents of the usual crankcase deposits in suspension. The compounded oils also have a strong tendency to break loose and carry away any existing crankcase deposits and since there is a limit to the amount that can be carried in suspension clogging of filters and oil lines may result. It is consequently of utmost importance to thoroughly clean out the crankcase, oil lines and sump tank before changing from a straight mineral oil to a compounded oil. As an added precaution we suggest that the first batch of compounded oil be used only for about 25 hours and then drained off. These precautions apply also when changing from one compounded oil to another compounded oil of different make or brand.

If a compounded oil is used the non-corrosiveness of this oil must be looked into very carefully. In this connection the Engineering Dept. of the Atlas Imperial Diesel Engine Co. is available for consultation and they will be glad to advise whether or not an oil is suitable for use in this engine.

With regard to viscosity grade our recommendations are that the viscosity at 130° F. be between 235 and 270 Secs. Saybolt Universal. This corresponds to an S.A.E. viscosity rating of 30 to 40. In other words, the oil to be used should be a heavy S.A.E. 30 or a light S.A.E. 40 oil.

In regard to drainage periods we suggest that the first batch of oil be drained after 100 hours of service. Thereafter the suggested drainage period is 200 to 250 hours. This period may be lengthened somewhat on engines which are equipped with waste packed filters. In that case if the filter cartridge is changed before the oil is badly discolored and loaded up with insolubles or foreign particles, drainage periods of 400 to 600 hours can be used. In the cases where no waste packed filters are used the oil will of course not be "worn out" after 200 hours of service if it is of a good grade. It will, however, be dirty and will contain insolubles which should be removed from the lubricating oil before it is re-used.

The same lubricating oil as used in the crankcase of the engine is also suitable for use in the mechanical lubricator. In the case of the mechanical lubricator, however, it is highly desirable that new oil be used.



INSTALLATION INSTRUCTIONS

## GENERATING UNITS

1. The success of an engine installation depends greatly upon the construction of the foundation and upon the care exercised in lining up the engine to the connected generator. Poor installations will result in excessive vibration and continual change in alignment. The result is poor performance and failure of vital parts. For this reason Atlas Imperial Diesel Engine Co. cannot guarantee an engine unless the instructions in regard to alignment given in the following have been followed.

For generating sets on board ship, in cranes and dredges, etc. two different arrangements are in common use. These two arrangements require different treatment as far as alignment between the engine and generator is concerned and will therefore be treated separately in the following. In one case, the foundation for the engine and generator is built into the hull or crane structure and virtually forms a part of this structure. In the second case, a separate steel sub-base is used upon which the engine and generator is mounted. This sub-base in turn is fastened to the hull structure. A separate structural steel sub-base under the engine and generator must always be used for marine installations in wooden hulls.

In the case where a separate steel sub-base is used, it is possible to finish the top of this sub-base so that the engine and the generator rests on finished surfaces which are then located properly with respect to each other. This is not possible when the engine bed forms a part of the hull or crane structure. In that case, the engine and generator supporting surfaces are only approximately plain surfaces and their location relative to each other is only approximately correct.

2. INSTALLING THE ENGINE AND GENERATOR ON A STEEL STRUCTURE INTEGRAL WITH THE HULL OR CRANE

When preparing the engine and generator foundation, always obtain certified outline prints. Do not use figures or cuts in bulletins or sales literature.

- (a) Preparing the Engine Bed

The top faces upon which the engine and generator will rest should as nearly as possible be straight planes and in the case of marine installations they should be level for the average ship trim. In a horizontal plane, the surfaces supporting the engine and those supporting the generator should be located so that the center line of the engine crankshaft and the center line of the generator shaft will line up. Athwartships the top surfaces supporting the engine and the top surfaces supporting the generator should be level. The foundation should be constructed so as to allow  $\frac{1}{2}$ " to 1" thick shims or chocks between the engine and the supporting top faces. In the case of the supports for the generator stator and the generator pedestal bearing about  $\frac{1}{4}$ " to  $\frac{1}{2}$ " should also be allowed for shimming.

The importance of rigidity in the engine and generator foundation can not be over-emphasized and it must be securely fastened to the hull or other structure so as to be virtually a part of this structure. Stiffeners should be fitted to prevent the foundation from twisting and weaving. The main foundation beams should be stiffly connected and braced to each other and to the hull or crane structure. Foundations should be welded or riveted and the use of bolts or screws, which may work loose, should be avoided.

- (b) Installing the Engine

In the case of marine installations, it is advisable to install the engine and generator and line them up relative to each other after launching. If the installation is done before launching, the engine and generator should be fastened to their foundations temporarily and the alignment should be checked up after the vessel is afloat. This particularly applies to smaller vessels.

The engine should be lowered onto its foundation and allowed to rest on the leveling screws. Shift the engine sideways and level it up until the crankshaft center line is located in the proper position. The vertical adjustment may be accomplished by means of the leveling screws and in the final position there should be about  $\frac{1}{2}$ " to 1" between the top of the foundation and the engine base supporting ledges. Next lower the generator stator, rotor and shaft and the pedestal bearing in place to ascertain that the foundation will allow line up with the engine as it is placed. These items may be left in place but should not be connected to the engine crankshaft or flywheel until later.



When it has been ascertained that line up of the engine and generator can be accomplished, shims or chocks under the engine base should be fitted. A chock should be carefully fitted under each foundation bolt with the engine resting on its leveling screws. The shims or chocks should be approximately the same width as the engine supporting ledges and should be about 4" to 6" long. The chocks under foundation bolts adjacent to dowels should be wide enough to extend beyond the dowel holes. Slots should be provided for the foundation bolts which should next be inserted. Then loosen up the leveling screws and tighten up the foundation bolts so that the engine is held firmly to the chocks and foundation.

It is now necessary to check that the foundation is supporting the engine evenly over the entire length. The easiest way to do this is to check up the alignment of the crankshaft. It will then be necessary to remove all the crankcase doors and apply a gap or strain gage as shown in Fig. C-1. As shown in this figure, two light punch marks should be placed directly opposite each other on each crank throw. A #696 Starrett Strain Gage or equivalent should be used and the distance between the inside faces of the crank webbs with the cranks on upper and lower centers should be checked. Readings for any one crank should not differ more than .002".

It is highly desirable that the flywheel be removed before the strain gage readings are taken. This is particularly desirable if the flywheel is unusually heavy. If the flywheel is left on the shaft, a somewhat larger difference than .002" may be expected on the adjacent crank. However, if the strain gage readings on all other cranks are within the value given, it may be assumed that the foundation is supporting the base properly.

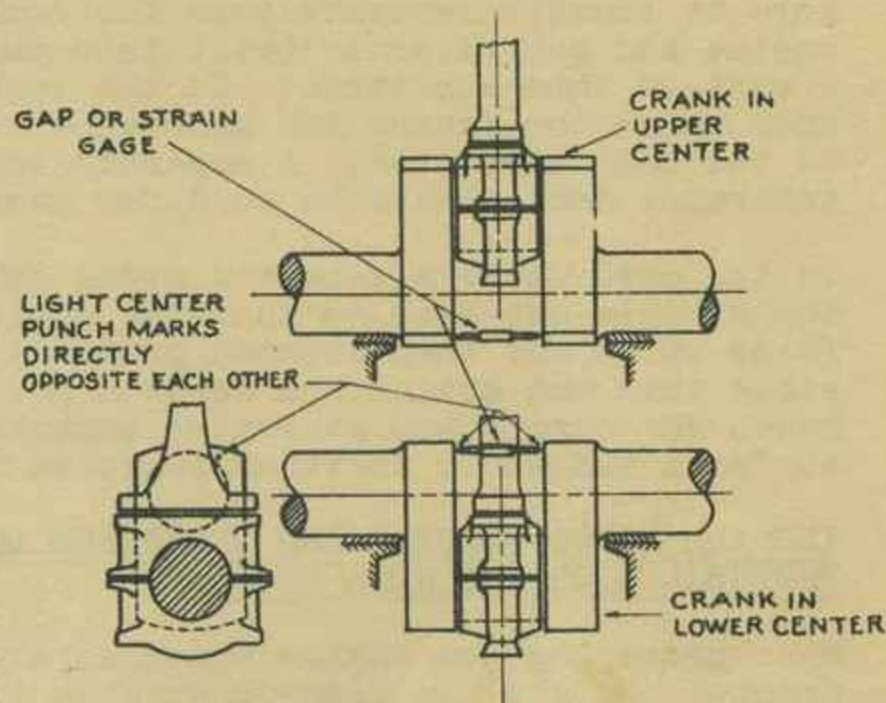

FIG. C-1

Note that during this checking operation, the engine should be firmly bolted down on its foundation and the crank shaft main bearing caps should be left in place. It is not necessary to remove the bearing caps and jack the crankshaft against the lower bearings as is done when main bearing wear is checked by means of a strain gage. The cylinder compression release valves should be open so that there is no cylinder compression at hand when making this check. If the strain gage readings show that uneven support is at hand, correction should be made and the test repeated before proceeding any further.

### (c) Lining up the Generator

If the flywheel was removed during the preceding operation, it should now be mounted and the generator shaft and outboard bearing can then be lined up. Usually the generator shaft is provided with a flange or a flanged coupling for bolting to the engine flywheel, and in some cases, it will be found convenient not to mount the generator stator until the generator shaft and outboard bearing have been lined up. This will facilitate the reaming of the dowel holes between the generator shaft flange and the flywheel. In order to understand the lining up procedures dealt with in the following, Figures C-2a to C-2f should be studied. In these figures the elastic deflections which are at hand are shown in a greatly exaggerated scale. The flywheel is located adjacent to the first crank and the generator rotor between the flywheel and the outboard bearing. The engine crankshaft center line is in each case designated by line C-C.

Fig. C-2a illustrates the condition that would be at hand if there were no elastic deflections in the engine crankshaft and the generator shaft. In that case the center of the outboard bearing should be located in line with the crank shaft center line. However, deflections and deformations take place in all cases due to the fact that the shafts are elastic and support the flywheel and generator rotor weights. Fig. C-2b and Fig. C-2c shows the deflections which would be at hand with the crank adjacent to the flywheel in the upper and the lower positions and the outboard bearing in line with the crankshaft



center. In that case strain gage readings on the last crank would show a greater value with the crank in the lower position (dimension X) than with the crank in the upper position (dimension Y). Actually the elastic deformations are usually carried over to the second crank but the deflections in this crank compared to those in the crank adjacent to the flywheel are usually small and in the figures deflections in the second crank are not shown.

Fig. C-2d illustrates that the lining up the generator shaft to the engine crankshaft by means of feelers between the flywheel and generator shaft coupling faces only locates the outboard bearing in an approximately correct position in the vertical plane. Fig. C-2f illustrates correct alignment of the generator shaft and outboard bearing. In this case, the strain gage readings with the crank on top center and with the crank at bottom center would be the same. It should be noted that the deflections in the figures are exaggerated and that it is usually not necessary to tilt the outboard bearing as shown in Fig. C-2f.

The first rough line up of the generator shaft is as follows: Enter the generator flange or coupling spigot into the corresponding flywheel bore until there is only a few thousandths between the flywheel and generator flange faces. Using feelers, shift the outboard bearing sideways and up and down until the distance between the flywheel and flange faces (dimension Z on Fig. C-2d) is equal in four planes. In other words, it should be just possible to insert, for instance, a 0.005" feeler between the outside of the generator flange and flywheel faces at top and bottom and midway at the two sides.

This procedure will give the correct sideways location for the outboard bearing but will not locate it correctly in the vertical plane as can be seen by referring to Fig. C-2d. In order to obtain the final vertical position of the outboard bearing, it is necessary to again use the strain gage on the crank adjacent to the flywheel. But before this is done, the generator shaft flange must be firmly bolted to the flywheel. Strain gage readings on the last crank will then usually show a greater value with the crank down than with the crank in the upper position and in order to eliminate this difference, it will be found necessary to raise the outboard bearing so as to obtain the condition shown in Fig. C-2f.

Strain gage readings should also be taken for the two horizontal positions of the crank to check the sideways location of the outboard bearing. The alignment can be considered satisfactory when all strain gage readings are within .002" but under no circumstances should there be any greater difference.

When the final alignment has been accomplished, the dowels should be fitted. The engine is provided with at least four dowel holes usually located close to foundation bolt holes. The chocks for the corresponding foundation bolt holes should be extended under the dowel holes. The dowel holes should be used as guides for drilling holes through the chocks and the foundation and all holes should then be line reamed for the dowels. It is essential that the dowels have a good drive fit both in the engine base and in the foundation. Although it is not necessary to do so, the holes for the hold down bolts can be reamed in the engine and the foundation and fitted bolts used. In that case, it is of course unnecessary to provide for dowels. Usually there is provision on the generator pedestal bearing and stator frame for dowels. However, if this is not the case, the holes for the hold down bolts must be reamed and fitted bolts

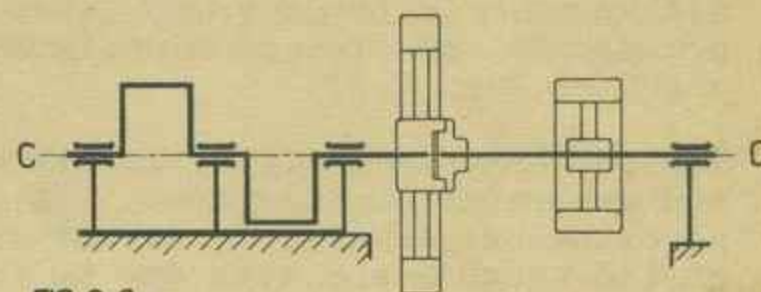

FIG. C-2a

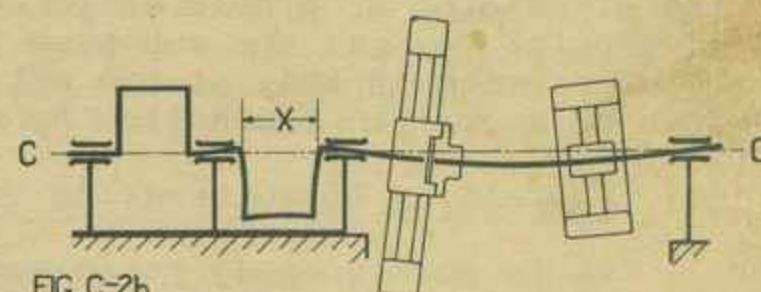

FIG. C-2b

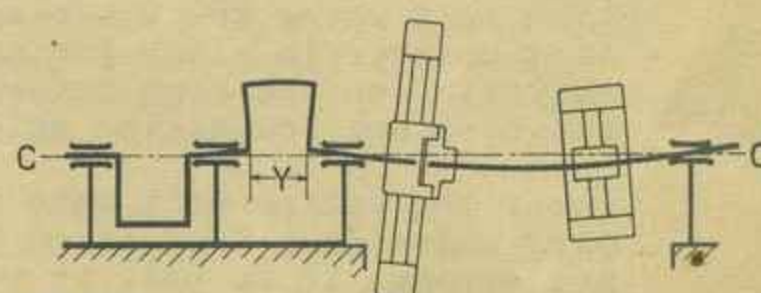

FIG. C-2c

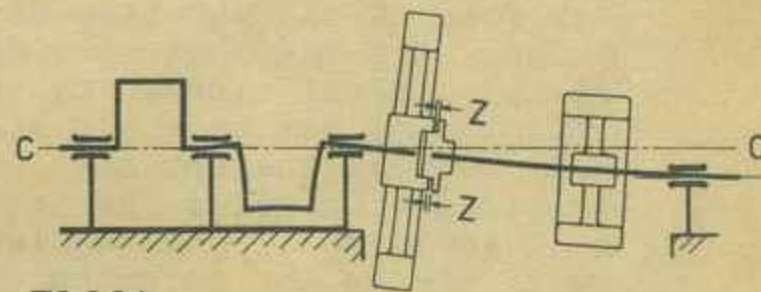

FIG. C-2d

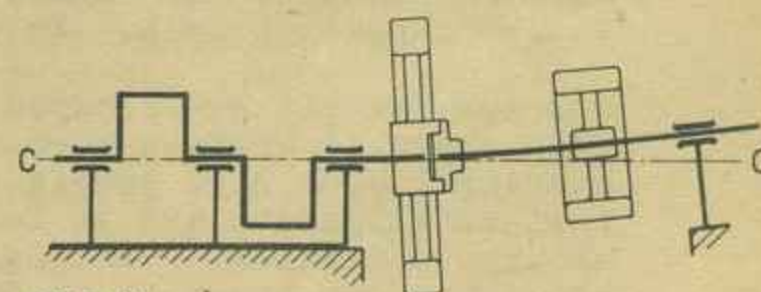

FIG. C-2f



## Section C

used Spaces between the chocks under the engine supporting ledges may be filled with type metal to insure a substantial support under the engine base.

### 3. INSTALLING THE ENGINE AND GENERATOR PROVIDED WITH STRUCTURAL STEEL SUB-BASE

Generating sets mounted on structural steel sub-bases have been carefully lined up at the factory and, when tested there, strain gage readings were taken to check the alignment. In other words, when the unit was tested at the factory, the engine crankshaft was free of misalignment strains; the alignment corresponding to that shown on Fig. C-2f.

The sub-base is a rigid structure and if installed correctly it will hold the engine and generator in alignment. It should be recognized however that the sub-base is nevertheless an elastic structure and as such is subject to deflections due to supported weights and also due to forces set up by tightening up on the foundation bolts. The resultant deflections are small but are nevertheless of importance from the standpoint of proper alignment. It is not practical from a weight and space standpoint to make the sub-base so stiff that it can not be deformed for instance, by supporting it only at the extreme ends or so stiff that it will resist pulling down on an uneven foundation by means of the foundation bolts.

#### (a) Installing the Generating Unit

It is consequently necessary to carefully shim under the sub-base after it has been lowered onto its foundation and a shim should be fitted under each foundation bolt where the sub-base does not rest on the foundation. It is not necessary however to allow for any specified thickness of shims. The base can be supported on the high points of the foundation and shims fitted between the sub-base and foundation only where necessary.

Lower the entire unit onto the foundation then ascertain if shimming is necessary under each foundation bolt in the following manner. Use a dial indicator and arrange it so that it is supported by the foundation structure (not the sub-base). Let the indicating arm of the instrument press down lightly on the top face of the sub-base directly above the foundation bolt which is being tried. Set the indicator dial to zero and tighten up the foundation bolt nut firmly. After tightening up, the indicator reading should still be zero. If this is not the case, it will be necessary to insert shims under the foundation bolt between the sub-base and the foundation. These shims should be slotted or provided with holes for the foundation bolt. Then tighten up the foundation bolt again and if the indicator reading is not zero, it will be necessary to again change the shimming until the indicator reads zero both before and after tightening up of the foundation bolts. Repeat this procedure for each and every foundation bolt. Then tighten up all the foundation bolts firmly.

The sub-base is now clamped firmly to the foundation and is deflected into the same shape it assumed when it was originally lowered onto the foundation and resting on the high points only. This may or may not be the right shape for perfect alignment and it is now necessary to check the alignment of the engine and the generator. The engine and the sub-base form an exceedingly stiff beam and therefore there is no danger that the engine itself has been pulled out of shape, but there is a possibility that misalignment may exist between the engine and the generator.

#### (b) Checking the Alignment of Engine and Generator

In order to check the alignment between the engine and the generator, it is necessary to remove the crankcase doors adjacent to the flywheel and check the final alignment by means of a strain gage as described in Paragraph 2c. By referring to Figures C-2a through C-2f, it can then readily be determined whether or not the generator end of the sub-base should be raised or lowered.

Considering the crank adjacent to the flywheel, if the strain gage reading with the crank down is greater than with the crank up, the generator outboard bearing should be raised up relative to the engine. In order to accomplish this, it is not necessary to break loose the generator and outboard bearing from the sub-base. Any misalignment which may exist can be corrected by adding shims under the sub-base. In case it should be necessary to add shims under the generator and outboard bearing end of the sub-base, all foundation bolts on this end should be loosened. Shims should first be added under the foundation bolts on the extreme end. These bolts should then be tightened up and the strain gage readings on the last crank repeated. If the addition of these shims corrected any misalignment situation which may have existed, a progressively lesser number of shims should be added under the foundation bolts as the engine is approached. As these shims are being fitted, an indicator should be used to



ascertain that the sub-base is not pulled out of shape when the foundation bolts are tightened up.

After the vertical alignment has been thoroughly checked, the horizontal alignment between the engine and the generator should be checked by means of strain gage readings on the last crank in the two horizontal positions. It sometimes happens that a sub-base is sprung during shipment or in handling. It is consequently advisable to also check the horizontal alignment between the engine and the generator. If misalignment is found to exist in the horizontal plane, it can not however be corrected by shimming under the sub-base. In that case, it is necessary to break loose the outboard bearing from the sub-base and shift it sideways until the correct alignment has been established.

#### 4. INSTALLING ENGINES CONNECTED TO TWO-BEARING GENERATORS

In this case the engine crankshaft and flywheel must always be connected to the generator shaft by means of a flexible coupling.

If the unit is mounted on a steel structure which is integral with the hull or crane structure, the instructions given in Paragraphs 2 (a) and 2 (b) apply to the preparation of the foundation and installation of the engine. The generator should then be lined up so that the center lines of the generator shaft and the engine crankshaft co-incide. This can usually be accomplished by means of feelers between the two flexible coupling halves. Shift the generator sideways and up and down until the distance between the faces on the two coupling halves is the same at top and bottom and the two sides. At the same time ascertain that the centers of the two coupling halves line up.

After the alignment has been accomplished it should be checked by means of strain gage readings on the crank adjacent to the flywheel. In this case the flywheel weight is supported by the crankshaft and it can consequently be expected that the strain gage reading with the crank down will be more than with the crank up. The difference should however not exceed .003".

If a structural steel sub-base is used under a generating unit consisting of an engine and a two-bearing generator, the unit should be installed in accordance with Paragraph 3(a). The final alignment should be checked in accordance with Paragraph 3(b). If the sub-base has not been sprung in shipment or handling and has been installed in accordance with the instructions in Paragraph 3(a), the alignment should be satisfactory and there should be no occasion for changing the shimming under the sub-base.

#### 5. SERVICE PIPING

Plan all piping carefully and use as short and direct lines as possible. To improve the general appearance of the installation, piping should be laid below the engine room floor when it is possible to do so. Removable floor plates should be provided and care should be taken that all piping is accessible.

#### 6. FUEL AND LUBRICATING OIL PIPING

See Section N for pipe sizes and arrangement of the fuel day tank. See Section T for lubricating oil day tank connections. Pipe sizes are stated in these Sections. Provide drain valves and vent valves where necessary and remove all scale and dirt from pipes and fittings before installing.

#### 7. COOLING WATER PIPING (Marine Installations)

Locate the sea chest far enough below the water line to prevent uncovering when the vessel rolls. It should be provided with a coarse grating. Inside the hull a strainer of ample size should be provided with gate valves on each side so that it can be isolated for cleaning. For engines equipped with centrifugal circulating water pumps it is particularly important that the resistance in the sea chest, strainer and piping be as small as possible. Use as few bends as possible and do not make either suction or discharge piping longer than necessary. Locate the overboard discharge not more than 3' above the water line. All valves should be gate valves - not globe valves. Use pipe sizes called for on the outline drawing.

#### 8. STARTING AIR PIPING

Air tanks should conform to A.S.M.E. specifications and should have ample strength for 250 lbs. per square inch pressure. Each tank should be equipped with a safety valve and a globe valve for isolation. A drain valve should also be provided at the lowest point and this valve should be accessible.



## Section C

Tanks should be connected to the engine starting air header using the pipe size called for on the outline drawing. Provide a globe valve next to the engine. All valves and fittings should be of heavy pattern for at least 250 lbs. per sq. inch pressure. If the engine is equipped with an air compressor it should be connected to the tanks with pipe of the size called for on the outline drawing and valves and fittings of heavy pattern. The air compressor discharge pipe should preferably be run to the air tank. It should not be connected to the piping between the tank and the starting air header. The air compressor unloader should preferably be connected to the tank with its own piping or tubing. Under no circumstances should it be connected to the compressor discharge line.

### 9. EXHAUST SYSTEM

All exhaust piping should be installed in the shortest and most direct manner possible. When bends are necessary use long sweep fittings. Use the pipe size called for on the outline drawing for lengths up to 20' containing a maximum of three bends. For 3 to 6 bends increase the pipe to the next nominal size and for each additional 30' length increase by one pipe size.

In order to protect the engine and piping from undue strains a length of flexible metal tubing should be installed as near to the engine as possible. It is also recommended that flanged connections be used for ease of dismantling and cleaning. For multiple installations it is necessary that separate exhaust lines be used. A.I.D.E. Co. will not approve of installations where the exhaust pipes for two or more engines are combined before reaching the atmosphere.



OPERATING INSTRUCTIONS

Before the operator attempts to run the engine, he should carefully study the chapters dealing with the mechanical details, especially the governor and fuel injection system. After familiarizing himself with the principles involved, the operator will understand the significance of the various movements of the control levers and will be able to handle the engine intelligently.

1. AIR STARTING SYSTEM - STARTING AIR LEVER

The starting air valves, located in the cylinder heads, are mechanically operated and are actuated from the camshaft by means of lifters or followers, push rods and rockers (see Section H). Wedges are interposed between the lifters and push rods and normally, before the engine is started and when it is running, the small ends of the wedges are located between the push rods and lifters allowing the latter to be lifted out of engagement of the cams by means of springs. The starting air wedges are pinned to levers which in turn are mounted on and operated by the starting air wedge shaft. This shaft is located in the push rod compartment of the cylinder block, approximately level with the fuel wedge shaft, on the inside. The starting air wedge shaft extends through the cylinder block and is operated by a lever located at the governor end. With the starting air shut-off valve closed the action of the wedges can be felt as the starting air lever is raised. Raising this lever moves the wedge shaft and wedges so that the big end of the wedges will be between the push rods and lifters, thus putting the latter in engagement with the starting air cams.

2. SPEED CONTROL

It is advisable to start the engine at a fairly slow speed and the operator should study Section Q dealing with the governor before attempting to start the engine. If the engine is equipped with a Woodward governor the load limit knob should be set at 4 or 5 before starting. In case the engine is equipped with a standard Atlas governor the speed control handle should be about half way up the quadrant.

3. INITIAL STARTING AND STARTING AFTER PROLONGED SHUTDOWN

(a) A final check should be given all fuel, air, lubricating oil and water lines, giving attention to the location and position of shut-off valves, check valves, etc. It is well to trace each system through making sure that there are no short circuits or blockages.

(b) For the initial starting it is well, although not absolutely necessary, to fill the pressure lines and passages of the lubricating oil system. For this purpose a small hand operated gear pump or piston pump can be used. When the pressure lines are full, a slight pressure will register on the pressure gauge. This procedure will insure lubricating oil pressure immediately upon starting.

(c) Hand oil the engine at all the points listed under "4-HOUR ROUTINE" in the "Maintenance & Inspection" Section. Fill the mechanical lubricator and turn its crank several revolutions.

(d) If the engine has previously been timed by means of fuel pressure or if it has been barred over several turns it is good practice to close the spray valve isolating valves and open the compression release valves and then turn the engine over on air until any excess fuel in the combustion chambers has been blown out.

(e) Check the oil level in engine sump, day tank or sump tank.

(f) If engine is radiator cooled check the water level in radiator.

(g) Bar the engine to place any one of the pistons 20° to 25° after top center. Compression release valves should be open when barring, then closed. (This operation is not necessary on 8 cylinder engines and can as a rule be omitted on 6 cylinder engines also.)

(h) Set governor control for approximately half speed and fuel pressure regulating valve at the third or fourth notch.

(i) Open the two vents on top of the high pressure fuel pump and operate the hand priming pump until fuel flows from both of these points. Then close these vents and pump up the fuel pressure to approximately 1500 lbs. per sq. inch by means of the priming pump handle on the high pressure fuel pump.

(j) Raise the starting air lever to the start position. The engine will then turn



## Section D

over on air. As soon as firing commences, move the starting air handle back to the running position. Run the engine slowly at first and control the speed by means of the governor. Adjust the fuel pressure to about 2500 lbs. per sq. inch. Then immediately check and watch the following:

1. Lubricating oil pressure and circulation. Observe oil level in day tank or sump tank. Engine will absorb several gallons when started up.
2. Circulation of cooling water. Do not run the engine longer than 2 minutes or at high speed unless water circulation has started. In some instances priming of the water pump will be necessary but do not prime until the engine is cool.
3. Oil and water leakage.
4. Hot bearings. Feel covers at intervals to locate any hot areas which would indicate hot oil from a hot bearing.
5. Feel water jackets and manifolds for even water circulation.
6. Check the response of the fuel pressure relief valve by moving the handle up and down and watching the pressure gauge.
7. Listen to the engine for evenness of firing and mechanical knocks.

(k) The engine should then gradually be brought up to full speed and the load can then be applied. Increase the load gradually and take about 30 minutes to increase to full load. As the load is applied increase the fuel pressure to 4000 to 4500 lbs. per sq. inch.

### 4. ROUTINE STARTING

Always check the positions of oil and water shut-off valves and make certain that no tools or the barring lever have been left where they can interfere with flywheel or shafting. After starting up check water circulation, lubricating oil level and pressure. The formation of a habit of checking these items automatically whenever the engine is started is likely to prevent accidents and serious damage. For routine starting it is only necessary to apply steps (e) to (j) in Paragraph 3 whereupon the fuel pressure can immediately be raised, the governor control set for full speed and the load applied.

### 5. RUNNING

The following items should be watched and regulated if necessary:

(a) Oil Pressure. The lubricating oil pressure should be maintained between 40 lbs. per square inch and 50 lbs. per square inch.

(b) Cooling Water Temperature. For Seawater Cooling the outlet temperature should not exceed 125° F. If Fresh Water Cooling is used the outlet temperature may safely reach 160° F.

(c) Fuel Pressure. The fuel pressure should be varied with the engine load. At full load a pressure of around 4000 to 4500 lbs. per square inch will give the best results. However, as the load is reduced the fuel pressure should also be lowered to prevent too great a withdrawal of the wedges. Too high a fuel pressure at low speeds causes very short injection periods resulting in roughness and uneven engine operation. About 2200 to 2500 lbs. per sq. inch is suitable for idling.

(d) Lubricating Oil Temperature. At the outlet of the oil cooler (if used) should not exceed 140° F.

(e) Mechanical Lubricator. The feed from the mechanical lubricator should be adjusted to 15 to 20 drops per minute per feed.

(f) Exhaust Temperature. The normal full load and speed exhaust temperatures range from 680 to 730 degrees. If the temperatures for all cylinders are above these limits overload is at hand. If the exhaust temperature for any one cylinder is too high or too low the injection system is probably at fault. (See Section 0)

(g) Exhaust Appearance. Observe the exhaust appearance. If it is smoky investigate the cause. In most cases the spray valves are responsible for smoke. (See Section on "Smoky Exhaust" under "Maintenance & Inspection".)

### 6. TO STOP THE ENGINE

If the engine is equipped with a standard Atlas Governor turn the stopping lever on top of the governor and hold it in the stop position until the engine has stopped.

On engines equipped with Woodward Governors turn the Load Limit Knob toward zero until the engine has stopped. The turning should be done slowly so as to not damage the governor mechanism. It is usually not necessary to turn the load limit knob all



the way to zero in order to stop the engine. If desired, the engine may be stopped without disturbing the governor setting by pulling the link connecting the governor linkage to the wedge shaft in the push rod compartment of the cylinder block. This pulls out the fuel wedges directly, without recourse to the governor action. A collapsible link in the mechanism permits this action without damage to the governor action.

D6 - Ed 1-3



LOWER BASE, CRANKSHAFT AND BEARINGS1. BASE

The cast iron base is heavily ribbed to support the main bearing saddles and to form a rigid structure upon which the engine is built. A trough extending longitudinally along the bottom serves as a drain for the lubricating oil, and accommodates the lubricating oil manifold, from which oil is piped to the main bearings and to the intermediate gear bearings. The construction of the oil sump in the bottom of the base is varied to suit the requirements of the installation, three different arrangements being in common use.

(a) The wet sump base, which is the most common application. A hopper shaped sump, bolted to the bottom of the base and extending below the mounting foot carries the lubricating oil supply for the engine. The single lubricating oil pump sucks directly from this sump and a bayonet gage in the side of the base indicates the depth of the oil.

(b) Dry base with separate sump. This arrangement is often used for stationary engines, where it is usually possible to locate a separate lubricating oil sump or day tank below the level of the engine. The bottom of the base is flush with the mounting foot of the engine, and the oil return from the bearings is piped from the end of the drain trough in the base to the sump tank.

The suction of the lubricating oil pump is connected to the sump tank and the pump discharges to the lubricating oil cooler and the main bearing manifold in the base.

(c) Dry base with sump pump. This arrangement is used primarily for marine engines, where a dry base engine is desired and it is impossible to locate a sump tank below the level of the engine. Two lubricating oil pumps are provided, the sump pump scavenging the oil from the bottom of the base and discharging into a day tank, and the pressure pump, sucking from the day tank and discharging to the oil cooler and manifold.

2. MAIN BEARINGS AND ADJUSTMENT

The crankshaft turns in babbitt lined steel backed bearing shells, held in place in the base by the main bearing caps. The crankshaft is located longitudinally by babbitt faces on the shells of the center bearing. The thrust clearance is .005" to .009" when new and should not be allowed to exceed .020". On four, five, and six cylinder engines, the same shells are also used on the flywheel end bearing but there are no mating thrust faces on the shaft so that they do not act as a thrust bearing.

Adjustment of the main bearings is by means of shims, and running clearance should set at .0045" to .0055" when the bearings are fitted. Bearing clearances can be accurately measured with two pieces of lead wire of about .025" diameter and one inch long, which are compressed between shell and journal about 1" from each end of the bearing by tightening the cap bolts. The thickness, measured with a micrometer, is the running clearance. Clearances should be checked annually, and should not be allowed to exceed .010". Keep shims even on both sides.

3. MAIN BEARING SHELLS

The bearing shells are prevented from rotating in the base by the shims, and are located fore and aft by a square head dowel pin in the bottom of the bearing saddles which engages a circumferential groove around the outside of the shell. As fitted, the shells project above the base and face of the caps from .002" to .003" on each side, but are squeezed down flush when the capnuts are pulled up. There should not be any appreciable clearance between the base, shim, and cap after final tightening. The bearing shells and caps are all numbered and must always be replaced in the bearing from which they were removed. Never interchange them, either from one bearing to another, or from top to bottom.

4. REMOVAL AND ASSEMBLY OF MAIN BEARINGS

After removing the cotter pins and main bearing nuts, the cap, upper shell and shims may be lifted out. As this operation is performed the positions of the numbers stamped on each of these parts should be noted so that the parts can be re-assembled in their proper positions. Unless the bearing is considerably worn it may not be possible to remove the lower shell by hand and it is usually necessary to turn it out of the base by barring the engine over after inserting a capscrew in the oil hole in the journal. The head of the capscrew will contact the edge of the bearing shell and roll the bearing out with the journal.



## Section F

When assembling the main bearing shells care must be taken to keep all parts absolutely clean. It is of utmost importance that any dirt be prevented from lodging between the shell and the saddle. Extreme care must be exercised in locating the bottom shell in a fore and aft direction before turning it into the base. Misalignment will cause the groove to miss the dowel pin in the base and trouble will then be encountered in backing the shell out again for another try.

### 5. CRANKSHAFT ALIGNMENT

The crankshaft should be checked at annual overhauls, or at intervals not greater than 7000 service hours, for misalignment due to uneven wear of the bearings. When the engine was erected at the factory the bearings were carefully scraped in, so as to bring the bearing surface of all shells in line. If one of these surfaces, due to uneven wear, becomes lower than the adjacent shells, it is evident that the crankshaft will be bent each time the adjacent cylinders fire and the connecting rods force the journal down against this low bearing. This condition must be guarded against, as neglect or ignorance of it will ultimately result in a broken shaft.

The simplest way to check crankshaft alignment is by means of a bridge gauge, which can be supplied with the engine as extra equipment. If a bridge gauge is desired it must, however, be ordered when the order for the engine is placed. It can not be supplied later.

With the bridge gauge straddling the journal and resting firmly and squarely on the bearing cap seats in the lower base, the distance between the top of the main bearing journal and the machined face on the bridge gauge is measured by means of a feeler gauge. At the time the engine was erected these measurements were taken and were stamped on the bridge gauge. As the age of the engine increases the bearing surfaces will wear, with the result that these measurements will gradually increase. As long as they all increase by the same amount the shaft will still be in line however, and there need be no worry, even though they do not agree with the original readings stamped on the bridge gauge. But if at any time the "wear down", or difference between the current reading and original reading varies by more than .004" between two adjacent bearings, the low shell should be replaced at once and the crankshaft re-aligned, a job that should be undertaken only by an experienced mechanic. A careful record should be kept of all bridge gauge readings taken from time to time.

The bridge gauge measurements described above should be made successively, removing one bearing cap at a time and replacing it before proceeding to the next bearing. When making measurements the crankshaft journal must be forced down against the shell by means of a jack bearing against the centerframe. Protect the shaft journal with a piece of wood or sheet copper. An indication of low bearing shells will usually be given by looseness of the shell in the saddle. If it is possible to

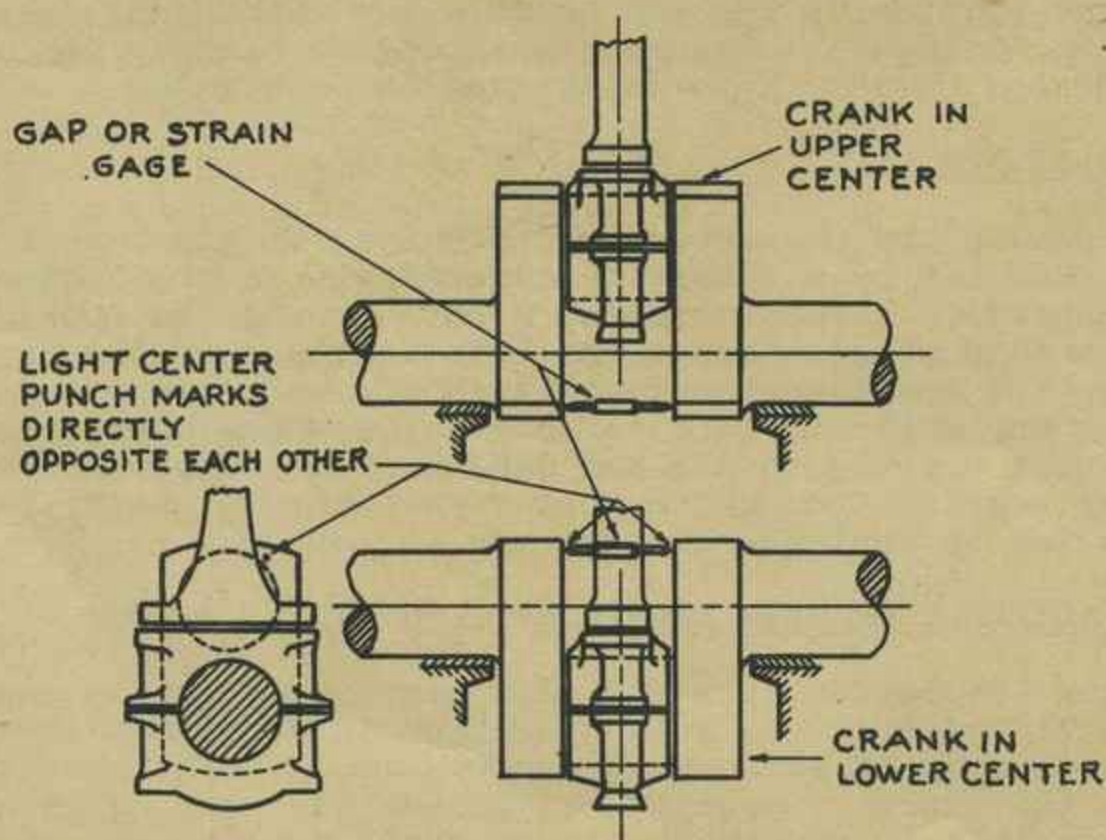

FIG. F-1



freely rotate one of the lower shells by hand when adjacent bearing caps are bolted down, it is quite probable that this shell is unduly worn and it should be checked with the bridge gauge at once.

If a bridge gauge is not available, crankshaft alignment may be checked with a gap or strain gage as follows: Stamp two center punch marks as shown in Fig. F-1 on all cranks. Starting with No. 1 cylinder crank, remove adjacent main bearing caps and locate the crank as near lower center as gap gage will permit. Using jack screws between bearing journal and center frame force shaft against lower bearing half (protect shaft with a piece of wood or sheet copper) and record the gap gage reading. Then loosen jackscrews and bar over until crank is on upper dead center. Again tighten jack screws and record the gauge reading. Repeat on all other cranks.

Comparison of gauge measurements in upper and lower centers will indicate crankshaft alignment conditions. Normally the measurements for the cranks in top position are slightly larger than measurements for the same cranks in the bottom position. However, the difference in measurement for any one crank should not exceed .0005" per inch of shaft diameter. If this is the case, realignment of the crankshaft bearings is indicated.

#### 6. FLYWHEEL AND OIL SEAL

The flywheel is bolted to the flanged end of the crankshaft, on the timing gear end of eight cylinder engines and on the opposite end on four, five, and six cylinder engines.

In the standard construction, the flywheel is centered on the outside of the crankshaft flange and the driven stub shaft flange is centered by a spigot engaging the flywheel bore. The coupling bolts are studded into the crankshaft flange and extend through the flywheel and stub shaft flange, nuts on the free end clamping the assembly together. These nuts should be tested at semi-annual inspections and should always be kept snug and securely cotter pinned. Dowel pins in reamed holes extend through the three pieces and take the torque drive. The flywheel is secured to the crankshaft during shipment by two flat head screws in countersunk holes.

In some special cases, particularly in generator drives, the crankshaft studs extend through the flywheel only, and the driven shaft is secured to the flywheel by a second set of coupling bolts on a larger diameter bolt circle, studded into the flywheel. The flywheel retaining nuts are recessed into the wheel and are covered by the stub shaft flange.

A labyrinth, formed by an oil thrower pressed on the outside of the crankshaft flange and mating with a split oil guard bolted to the end of the engine base constitutes the oil seal around the crankshaft at the flywheel end of the engine. On standard engines the opposite end of the crankshaft is brought out through the base for any auxiliary drives that may be required. On four, five, and six cylinder engines a key way is provided and the driven pulley is pressed or clamped on the end of the shaft. An oil thrower pressed on the shaft and a felt packed oil guard form the oil seal. On eight cylinder engines the driven pulley is bolted and doweled to the end of the shaft and a standard commercial oil seal is used, pressed into the forward end cover. If the forward drive is not used a cap may be placed over the end of the shaft.

NOTE: The torsional vibration conditions in the engine crankshaft are appreciably affected by the dimensions of drive pulleys mounted on the end of the crankshaft opposite the flywheel. Whenever an engine is equipped at the factory with auxiliary drive pulleys the torsional vibration stresses have been carefully calculated for the particular pulley that is supplied. It is important therefore that no changes in size or dimensions be made on this pulley unless approval has first been obtained from the Engineering Department of Atlas Imperial Diesel Engine Co. It is likewise important that no auxiliary drive pulleys be added to an engine not originally equipped with them unless approval has first been obtained from the Atlas Engineering Department. The Atlas Imperial Diesel Engine Co. will not be responsible for any crankshaft breakages in cases where pulleys have been added or changed without approval.



CENTERFRAME--CYLINDER BLOCK & LINER, CYLINDER HEAD & VALVES1. CENTERFRAME

The centerframe, which rests on the engine base and supports the cylinder block, carries the camshaft bearings and forms the crank case housing. The tie bolts are studded into the base and extend up through the centerframe and into the cylinder block, where recesses are provided in each side for the nuts. The centerframe is located on the base and the cylinder block on the centerframe by dowels. Crank case sealer is used to make the joints between the three pieces, and if these joints are disturbed the old sealer must be thoroughly scraped off and replaced by new sealer when reassembling. Glyptol Lacquer is recommended for sealer.

2. CYLINDER BLOCK AND CYLINDER LINERS

The individual cylinder liners are mounted in the cylinder block, which forms the water jacket surrounding the liners and supports the cylinder heads. A compartment on the camshaft side of the cylinder block encloses the valve lifters, push rods, starting air manifold and the wedge shafts controlling the fuel and starting air valves.

The cylinder liners are special alloy iron castings, heat treated to relieve stresses and secure correct hardness. They are accurately machined to close tolerances and should be handled carefully and care taken not to damage the fits at top and bottom. Spare liners should always be stored in a vertical position and should be securely fastened down if stored on board ship. The water seal at the bottom of the liner consists of two rubber grommets which should always be replaced with new ones whenever a liner is pulled. When lowering a liner into place, grease the grommets freely with cup grease and use care to enter the grommets into the cylinder fit or they may be pinched and damaged. The liner has from .002" to .005" clearance in the cylinder at both top and bottom fits and no difficulty should be encountered in installing a new liner. A paper gasket .010" thick is used for the upper water seal between the liner and cylinder, and a new gasket should always be used when replacing a liner. The fits and shoulders on both liner and cylinder should be carefully scraped and wiped clean to assure a water tight joint. Care must be taken not to damage these shoulders, as a water leak will result.

Pockets are cut into the bottoms of the liners for connecting rod clearance, and dowels in the tops of the liners engage keyways in the centerframe and assure correct orientation of the liners. Nipples, screwed into the liners and projecting through the side of the cylinder block, feed oil to the pistons from the mechanical lubricator. Packing glands form the water seal at the cylinder block wall.

3. CYLINDER HEAD

The individual cast iron cylinder heads are carefully designed for strength and uniform cooling. The area above the liner is fully water jacketed, and a housing extends out from the camshaft side of the head to mate with the opening in the top of the push rod compartment in the cylinder block. The six cylinder head bolts are studded into the cylinder block, and the head is centered by a spigot which engages a counterbore in the top of the liner. A 1/32" thick copper gasket under the spigot forms the gas seal, and a soft cork gasket around the push rod compartment opening makes an oil tight seal at this point and still allows the head to be pulled down tightly on the copper gasket. Brass bushings screwed into the tops of the cylinder block and extending up into drilled holes in the head carry the cooling water into the head. They are sealed by rubber grommets, which should always be replaced by new ones when a head is pulled. When replacing a head, carefully wipe all dirt from the lower surface and thoroughly clean both sides of the copper gasket, as well as the surfaces of the head and liner which bear against it. Always use care to protect the spigot on the bottom of the head, as nicks and scratches will result in a leaky joint. Place heads on wooden blocks, never on concrete floor or steel deck, and use care that spare heads are not damaged in storage and handling. Covers over the tops of the heads fully enclose the valve rockers and push rods. The covers are split horizontally, the lower half bolted down against a gasket. The top cover is hinged to the lower half and is held in place by wing nuts, making the valve operating gear readily accessible for inspection and oiling.

4. INLET AND EXHAUST VALVES

The one piece forged steel inlet and exhaust valves seat directly in the head and are guided in replaceable cast iron bushings pressed into the head. The exhaust valves are forged of a special heat resistant alloy steel and may be distinguished from the inlet valves by the "EXH" and "INL" stamped on the valve heads. The inlet valves are forged of chrome nickel steel and are not suitable for exhaust valves.



## Section H

They should never be used interchangeably, except in an emergency, and then for a short period only.

Two concentric valve springs are used on each valve. They are centered by the valve guide and are held in place by a retainer which is secured to the valve stem by means of a split taper collar. Depressing the retainer against the spring permits removal of the collar and disassembly of valve and springs.

If valve faces are badly pitted they should be refaced on a lathe, as excessive grinding to remove pits will wear down the seats in the heads unnecessarily and will also cut a groove in the valve face. Badly pitted seats should also be refaced with a seat reamer before grinding, taking particular care to keep the seat concentric and square with the bore of the guide. Always finish the grinding with fine compound. Use extreme care that no grinding compound is introduced into the guide, and thoroughly remove all traces of compound when reassembling, and lubricate the valve stems with clean engine oil. The valve guides should be replaced if excessively worn, and new guides must be reamed to .6250" - .6255" diameter after pressing in. The inlet and exhaust valve stems should be oiled every four to eight hours while the engine is in operation. See detailed instructions in Section Z.

### 5. STARTING AIR VALVE

The starting air valve is seated directly in the head and is guided by a bushing which works in the head and to which the valve stem is clamped. Two piston rings form the air seal between the bushing and the head. The bushing is secured to the valve by a nut on the end of the stem. It rests against a shoulder on the valve stem, and a piece of steel tubing slipped over the stem serves as a spacer between the top of the bushing and the spring retaining washer, against which the nut bears, and also acts as a guide for the spring. The lower end of the valve spring bears against a washer which rests on the cylinder head. The valve operating gear is described in Section L. The instructions in Paragraph 4 regarding grinding the inlet and exhaust valves apply also to the starting air valves. Leaky starting valves may be detected by excessive heating of the starting air manifold connection leading to the valves.

### 6. COMPRESSION RELEASE OR SNIFTER VALVES

The compression release or snifter valves are located at the bottom of the cylinder heads, on the camshaft side. They permit release of the cylinder pressure when barring over the engine and are also used as shut off valves when indicating or taking compression pressures.

The hole tapped in the cylinder head for the snifter valve is located at the inner side of the push rod compartment and the body of the valve extends across this compartment and projects out through the outer cylinder head wall. The valve seat is at the inner end of the body, and the long needle valve stem is threaded to the body at its outer end.

### 7. SAFETY VALVES

The safety valves are located on the manifold side of the cylinder heads, in tees screwed into tapped holes communicating with the cylinder combustion chambers. They are spring loaded relief valves, and serve to relieve excessive cylinder pressures, acting as telltales to indicate that the pressures are too high. The popping of these valves is a definite indication that something is wrong and should be investigated at once.

The valves are adjustable by tightening the spring retaining cover, and should be set to relieve at 800 lbs. per square inch. A setscrew locks the collar to retain the setting. They should be tried out occasionally by prying up the lower spring washer with a screw driver, to assure that they are in operating condition.



PISTON AND CONNECTING ROD1. PISTON

The pistons which are of the one-piece, solid-skirt type are made of high grade cast iron and are heat treated to relieve stresses and to obtain proper hardness. The piston is ground straight, that is without taper, from the bottom up to the ring belt. The clearance in the liner is .009" to .011". The head of the piston being exposed to high temperatures is given a larger clearance, approximately .0055" to .006" per inch of bore diameter.

2. PISTON PIN

The case hardened and ground piston pin is stepped, with differential fits in the piston pin bosses. The fits are about .0005" to .0015" press on the large end and metal to metal to .001" loose on the small end. Rotation of the pin in the piston is prevented by the engagement of a dowel which projects radially from the large end of the pin with a groove in the bottom of the boss. A setscrew threaded into the larger pin boss enters an indentation in the pin to act as a retainer. The setscrew is in turn secured by a locknut.

3. PISTON RINGS

There are 6 rings per piston, an oil ring above and below the piston pin and four compression rings. Always assemble the oil rings with the bevel up, to slide over the oil film on the upstroke and scrape it down on the return. When overhauling pistons, thoroughly clean all carbon from rings and grooves and top of piston. Fuel deposit on the piston skirt can best be dissolved with cleaning solvent or paint remover. Be sure oil drain holes below oil rings are open.

Check rings for side clearance in grooves and end clearance, as measured in place in the liner. Side clearance should be .003" to .005" with new pistons and rings and end or gap clearance .005" per inch of bore diameter for the two top rings. For the other rings the gap clearance should be .003" per inch of bore diameter.

Rings should be discarded when the side clearance exceeds .008" and the end clearance .007" to .008" per inch of bore diameter. It is also a good policy to discard any rings which have been stuck for any length of time as they are apt to be out of round and may not hold compression. Always check new rings, measuring the side clearance, in the groove in which the ring is to run, with feeler gauge, and the end clearance with the ring in the liner at the smallest diameter. Never install rings with less clearance than that given above. As the oil rings wear the width of the flat increases, with consequent decrease in width of bevel and oil scraping ability. Experience will determine permissible wear without excessive oil pumping.

4. CONNECTING ROD

The connecting rods are steel drop forgings, rifle drilled to carry oil to the piston pins. Shims between foot of rod and crankpin box provide adjustment to balance compression pressures in the cylinders to the desired value. The distance "X" (see Fig. K-1), between the top of the piston and the top of the liner should be 7/16". When taking measurement "X" the piston should be at top dead center and the cylinder liner must be securely clamped down into the cylinder. The cylinder stud nuts must also be tight when making this adjustment. The above connecting rod adjustment should be used for altitudes from sea-level to 1500' and will then produce compression pressures of 400 to 410 pounds per square inch. If the engine is located at higher altitudes than 1500 feet above sea-level dimension "X" should be smaller and in accordance with the following tabulation:

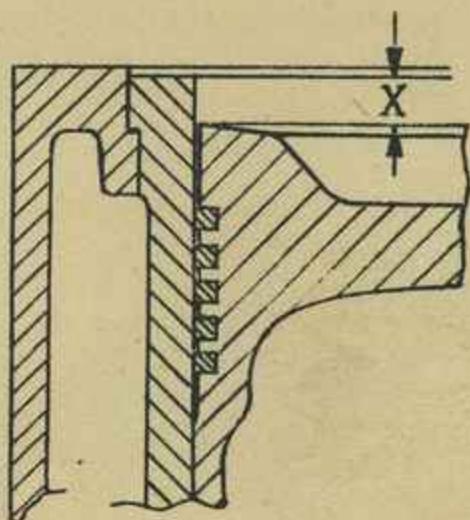

FIG. K-1

Altitude Ft. Above Sea Level	Dimension "X" Inches
2000	.384
4000	.341
6000	.290
8000	.245
10000	.202

A bronze bushing for the piston pin is pressed in the upper end of the rod. If this bushing is replaced it must be reamed to allow a piston pin clearance of .0015" to .0025". Care must be taken to keep the reamed hole exactly parallel with the foot of the rod. The oil grooving in the bushing is carefully designed for correct lu-



PISTON AND CONNECTING ROD1. PISTON

The pistons which are of the one-piece, solid-skirt type are made of high grade cast iron and are heat treated to relieve stresses and to obtain proper hardness. The piston is ground straight, that is without taper, from the bottom up to the ring belt. The clearance in the liner is .009" to .011". The head of the piston being exposed to high temperatures is given a larger clearance, approximately .0055" to .006" per inch of bore diameter.

2. PISTON PIN

The case hardened and ground piston pin is stepped, with differential fits in the piston pin bosses. The fits are about .0005" to .0015" press on the large end and metal to metal to .001" loose on the small end. Rotation of the pin in the piston is prevented by the engagement of a dowel which projects radially from the large end of the pin with a groove in the bottom of the boss. A setscrew threaded into the larger pin boss enters an indentation in the pin to act as a retainer. The setscrew is in turn secured by a locknut.

3. PISTON RINGS

There are 6 rings per piston, an oil ring above and below the piston pin and four compression rings. Always assemble the oil rings with the bevel up, to slide over the oil film on the upstroke and scrape it down on the return. When overhauling pistons, thoroughly clean all carbon from rings and grooves and top of piston. Fuel deposit on the piston skirt can best be dissolved with cleaning solvent or paint remover. Be sure oil drain holes below oil rings are open.

Check rings for side clearance in grooves and end clearance, as measured in place in the liner. Side clearance should be .003" to .005" with new pistons and rings and end or gap clearance .005" per inch of bore diameter for the two top rings. For the other rings the gap clearance should be .003" per inch of bore diameter.

Rings should be discarded when the side clearance exceeds .008" and the end clearance .007" to .008" per inch of bore diameter. It is also a good policy to discard any rings which have been stuck for any length of time as they are apt to be out of round and may not hold compression. Always check new rings, measuring the side clearance, in the groove in which the ring is to run, with feeler gauge, and the end clearance with the ring in the liner at the smallest diameter. Never install rings with less clearance than that given above. As the oil rings wear the width of the flat increases, with consequent decrease in width of bevel and oil scraping ability. Experience will determine permissible wear without excessive oil pumping.

4. CONNECTING ROD

The connecting rods are steel drop forgings, rifle drilled to carry oil to the piston pins. Shims between foot of rod and crankpin box provide adjustment to balance compression pressures in the cylinders to the desired value. The distance "X" (see Fig. K-1), between the top of the piston and the top of the liner should be 7/16". When taking measurement "X" the piston should be at top dead center and the cylinder liner must be securely clamped down into the cylinder. The cylinder stud nuts must also be tight when making this adjustment. The above connecting rod adjustment should be used for altitudes from sea-level to 1500' and will then produce compression pressures of 400 to 410 pounds per square inch. If the engine is located at higher altitudes than 1500 feet above sea-level dimension "X" should be smaller and in accordance with the following tabulation:

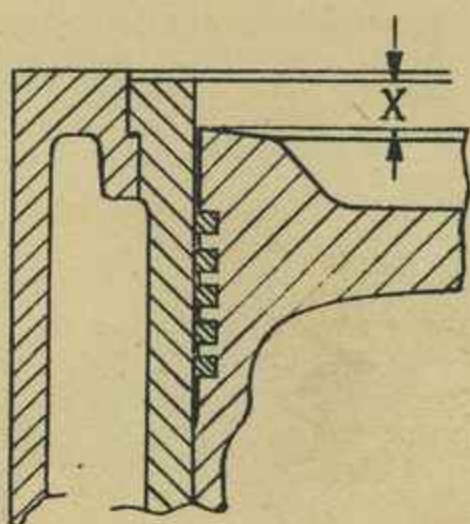

FIG. K-1

Altitude Ft. Above Sea Level	Dimension "X" Inches
2000	.384
4000	.341
6000	.290
8000	.245
10000	.202

A bronze bushing for the piston pin is pressed in the upper end of the rod. If this bushing is replaced it must be reamed to allow a piston pin clearance of .0015" to .0025". Care must be taken to keep the reamed hole exactly parallel with the foot of the rod. The oil grooving in the bushing is carefully designed for correct lu-



CAMSHAFT AND VALVE OPERATING GEAR1. CAMSHAFT

The camshaft is made of 2" ground steel shafting. The keyways in the shaft are indexed for the firing sequence stamped on the engine nameplate. Number 1 cylinder is located at the governor end of the engine.

2. CAMSHAFT BEARINGS

The camshaft bearings are accurately machined cast iron blocks with pressed in bronze bushings. Bearing bore in bushing is reamed to 2.004" - 2.005" diameter, which allows a running clearance of .004" to .006". If replaced the bushings must be reamed, and oil and mounting holes drilled through after pressing in. A groove must be chipped to communicate with the oil hole if it does not intersect the groove in the bushing. The bearing blocks are held in machined seats cut in the webs of the centerframe and are secured by capscrews.

The camshaft thrust is carried by the bearing adjacent to the drive gear, the hub of the drive gear and the end of the first cam engaging the ends of the bearing. Various combinations of thrust washers are used on different engines, and must always be replaced when assembling the shaft exactly as removed. The first cam should be located on the shaft to allow .015" to .020" thrust clearance. The thrust bearing is oiled by a line from the sight feed lubricator and the bearing at the other end of the shaft by an oil cup, which should be filled daily. The remaining camshaft bearings are lubricated by spray from the connecting rod boxes. Catch basins in the tops of the bearings collect the oil.

3. CAMS

The cams are accurately ground to shape after being case hardened. The fuel valve cam consists of a case hardened steel disc in which a case hardened steel toe is inserted. This toe controls the action of the spray valve, the disc serving as a base circle. The cams are a sliding or light tap fit on the camshaft and are held in position by taper keys driven securely into place after the cams have been located to line up with the lifter rollers. The exhaust cams serve as hubs to which the fuel cam discs are bolted, while the inlet and starting air cams are machined on opposite ends of common hubs. Progressing from the governor end of the engine, the cam sequence is inlet, air starting, fuel and exhaust on right hand engines and exhaust, fuel, air starting and inlet on left hand engines. The fuel cams are located on the cylinder center lines.

4. CAMSHAFT REMOVAL

In order to remove the camshaft from the engine it is necessary to remove the centerframe covers, including the governor and lubricating oil pump assemblies, and also the gear casing. Before removing the latter the camshaft gear should be pulled from its hub and the intermediate gear and high pressure fuel pump removed. The push rods should be removed and the lifters raised and clamped or blocked up clear of the shaft. Hose clamps may be used to advantage. Remove the camshaft retaining bolts, and the shaft may then be driven out. Sledge each bearing out of its seat a little at a time, using a timber inserted through the door openings in the opposite side of the centerframe. The end of the timber should be placed as close to the bearing as possible. The fits of the bearings in their seats can be relieved somewhat by loosening the cylinder block nuts on the camshaft side.

5. CAMSHAFT DISASSEMBLY

After the camshaft has been removed from the engine it should be carefully measured up and an accurate sketch made for use when reassembling. Note the exact position of each cam, the lubricating oil pump gear, thrust washers, etc. Note the numbers stamped on the bearings and be sure that they are replaced in the same positions. If the original bearings are replaced, holes for the centerframe door retaining bolts must be drilled and tapped in the new bearings to match the holes in the doors. Use a 27/64" drill, 1" deep, and a 1/2"-13 tap.

The cams are loosened by driving against the small end of the taper keys with a drift. FOR RIGHT HAND ENGINES THE KEYS ARE LOOSENED BY DRIVING AWAY FROM THE DRIVE GEAR END OF THE SHAFT, AND FOR LEFT HAND ENGINES BY DRIVING TOWARD THE DRIVE GEAR END. The engines are designated right or left hand according as to whether the control side of the engine is on the right or left of an observer facing the timing gear end of the engine. The lubricating oil pump gear located near the center of the shaft, adjacent to one of the exhaust cams, is also secured by a taper key. The slope of this key is opposite to that of the cam keys so that the large ends of



## Section L

the keys in the gear and the exhaust cam butt against each other and it is impossible to drive either key out. The gear may be loosened, however, by driving it away from the cam, using a brass bar or babbitt hammer.

The cams should slide on the shaft freely after the keys have been removed, but if it should be necessary to drive them off, only a babbitt hammer or brass drift should be used. Any burrs, particularly at keyways, must be dressed down with a file. If this precaution is not taken the cams may seize as they are removed and forcing the cams the remainder of the distance will score the shaft. The drive gear hub is shrunk on the shaft and secured by a taper key, driven in from the free end. There should not be any occasion for removing this flange, as it is not subject to wear, and if the camshaft is replaced a new flange will be furnished with the new shaft.

### 6. CAMSHAFT ASSEMBLY & INSTALLATION

When the camshaft is being reassembled the same precautions with regard to burrs apply. Coating the bores of the cams with white lead will aid materially in sliding the cams into place without scratching the shaft. The bores of either new or old cams should be inspected carefully for any defects likely to scratch the shaft. Bearings and cams are installed successively from the gear end. The bearings are located on the shaft in accordance with the sketch made prior to disassembly, and are locked in place by driving in the taper keys. FOR RIGHT HAND ENGINES DRIVE EACH KEY TOWARD DRIVE GEAR END OF THE SHAFT. (LARGE ENDS OF KEYS SHOULD POINT AWAY FROM GEAR END.) FOR LEFT HAND ENGINES DRIVE EACH KEY AWAY FROM THE GEAR END (LARGE ENDS OF KEYS SHOULD POINT TOWARD GEAR END.) Note that the slope of the key for the lubricating oil pump drive gear is opposite to that of the cams, as explained in Paragraph 5. The parts can be assembled by driving the gear home against its key. The assembled camshaft is then installed in the engine. After starting each cam bearing in its seat the bearings are driven into place a little at a time with a heavy brass bar. Each bearing should be driven a little and then left until all the others have been knocked in the same amount so that the camshaft will not be bent. The cam bearings will seat more easily if the cylinder block nuts are loose. The gear casing and the intermediate gear should next be assembled and the engine timed in accordance with the detailed instructions given in Paragraphs 11 and 12 after which the governor, lubricating oil pump and high pressure fuel pump assemblies may be replaced on the engine.

### 7. VALVE LIFTERS

The steel valve lifters work in cast iron guides bolted to the top of the center-frame and carry case hardened rollers on steel pins on their lower ends. Clearance between lifters and guides is .0015" to .0025", between rollers and pins is .001" to .002", and the pins are riveted into the lifter forks, with the ends flush, so that they may enter the guide bores.

Wedges, linked to control shafts extending along each side of the lifters and mounted on brackets bolted to the centerframe, are interposed between the fuel and air starting lifters and their push rods, and provide means of control of the fuel and air starting valves. The operation of the fuel valve mechanism is fully described in Section O under FUEL SYSTEM. The starting air valve wedges are withdrawn when the engine is running. This has the effect of shortening the push rods, and springs under the lifters hold the push rods and lifters up, with the rollers clear of the cams. When the engine is to be started the wedge shaft is rotated by means of a hand lever on one end, pulling the wedges in between the lifters and push rods. The lifters are forced down against the cams, which then operate the starting air valves, admitting air to the cylinders in the proper sequence for starting the engine.

### 8. PUSH RODS

The push rods for the fuel rockers are fabricated from seamless steel tubing, while those for the inlet, exhaust and air starting rockers are solid rods. Steel ends are welded to the tubing forming fuel rods, the lower end rounded to fit into the lifter guide and the upper end forming a socket to receive the adjusting screw in the fuel valve rocker. Sockets are screwed onto the upper ends of the inlet and exhaust and air starting push rods and receive ball studs which are pressed into the rockers. Push rod adjustment is made by screwing the sockets up or down on the rods, and is locked by jam nuts.

### 9. VALVE ROCKERS

The valve rockers are fulcrumed on a shaft supported by a bracket bolted to the top of the cylinder head. The shaft is secured in place in the bracket by two setscrews and is drilled for lubrication, a grease gun fitting at one end supplying grease to the rocker bearings. A grease gun is provided with the engine tools and the bear-



ings should be serviced daily. Bronze bushings in the rockers are reamed to 1.5010" to 1.5015" after pressing in, which allows .001" to .0025" clearance on the shaft.

The case hardened rollers on the valve ends of the inlet and exhaust rockers work directly on the ends of the valve stems and turn on headed pins, secured in the rockers by cotter pins. The roller clearance on the pins is .0005" to .0015". A hardened steel button pressed into the air starting valve rocker bears against the valve stem. A secondary rocker is used for the fuel valve, mounted on a shaft carried by a separate bracket. The main rocker bears down on one end of this secondary rocker, the other end of which lifts the spray valve as the mechanism operates. The action is more fully described in Section O. The bronze bushing in the secondary rocker should be reamed to .7500" to .7505" after pressing in, which allows .0005" to .0015" clearance. The shaft is held between the bearing retaining bolts. An oil hole in the top of the rocker provides for lubrication and should be hand oiled daily. Both rockers are steel forgings, and the bearing surfaces are case hardened.

#### 10. TIMING GEAR TRAIN

The camshaft is driven from a gear on the crankshaft by means of an intermediate gear. On four, five, and six cylinder engines the crankshaft gear is shrunk on the shaft. If replaced the new gear should be heated to approximately 600° F. and slipped over the shaft. Do not overheat the gear, as this will damage the steel structure. Once it is started on the shaft move it immediately to its final position against the shoulder at the fit, as it will be impossible to move it further once it begins to cool and seize the shaft.

On eight cylinder engines the crankshaft gear is split, and is held in place on the shaft by split collars clamped over each end of the gear.

The intermediate gear turns on a pin mounted in a bracket bolted to the end of the centerframe. The bracket is positioned and doweled to the centerframe to allow .006" to .008" gear backlash, and the pin is retained in the bearing bracket against a shoulder by nut and washer on the end of the shaft. Radial clearance between gear end and pin is .0015" to .0025", and side clearance is 1/32". Lubrication is positive from the engine force feed system.

The camshaft drive gear is bolted and doweled to the hub shrunk on the end of the camshaft. Unless the crankshaft or camshaft gears are replaced these dowels need not be disturbed, but if either of the gears is replaced the camshaft gear must be redoweled to its hub, after the shaft has been timed in accordance with instructions in Paragraph 12. Use a #U (.368" Dia.) drill and ream to .372"-.373" diameter for 3/8" dowels.

#### 11. CAMSHAFT TIMING (Reassembling with Original Gears)

In order to time the engine it is necessary to position the camshaft gear on its hub and to mesh the gears so as to obtain the correct relation between the two shafts, and then to adjust the push rods to open and close the valves at the correct points. Unless the crankshaft or camshaft gears have been replaced the camshaft can be correctly timed after overhauling by meshing the gears according to the timing marks that were stamped on the gear teeth when the engine was erected. Prick punch marks are stamped on the ends of the mating teeth on the crankshaft, intermediate and camshaft gears. Three teeth are stamped at each meshing point, a tooth on one gear and the two straddling teeth on the mating gear.

#### 12. CAMSHAFT TIMING (Reassembling after replacing gears)

If either the crankshaft or camshaft gears have been replaced, the camshaft can be timed as follows:

- (a) Spot No. 1 piston 2½° B.T.C.
- (b) Set the camshaft gear relative to its hub so that clamping bolts are approximately in the center of the slots. Orient camshaft gear so that old dowel holes will not interfere with redowelling.
- (c) Turn the camshaft (with intermediate gear out of mesh) so that the inlet and exhaust lifters of No. 1 cylinder are each raised an equal distance. (NOTE: The piston was set at 2½° B.T.C. as this is the mean position between the 10° B.T.C., opening of the inlet valve, and the 5° A.T.C., closing of the exhaust valve, and at this position both valves should be open an equal distance.)
- (d) Holding crankshaft and camshaft in above positions and allowing camshaft gear to slip on its hub as required, mesh the intermediate gear and tighten the clamp bolts between the camshaft gear and hub. After all valves have been timed and checked, drill and ream the dowel holes as described in Paragraph 10.



## Section L

### 13. SPOTTING THE PISTON

Before proceeding with the discussion on valve timing the following instructions regarding the correct method of spotting a piston should be considered. Whenever a piston is to be spotted for valve setting it should be brought into position by turning the engine in the direction of rotation in order to take up all gear backlash. If the engine is turned past the desired position, it should be turned well back in the opposite direction, and then again brought up to the required point.

### 14. POINTER LOCATION

The location of the flywheel pointer should be checked occasionally by "splitting the center". With one of the cylinder heads removed crank the engine to a point about  $20^{\circ}$  off top center. Measure the exact distance from the top of the liner down to the piston and observe the pointer reading on the flywheel. Then set the piston to the same distance below the top of the liner on the other side of top center and observe the flywheel pointer reading. If the readings do not agree adjust the pointer to give equal readings on each side. The position of the piston should preferably be taken with an indicator and in each case the piston should be cranked upward into position.

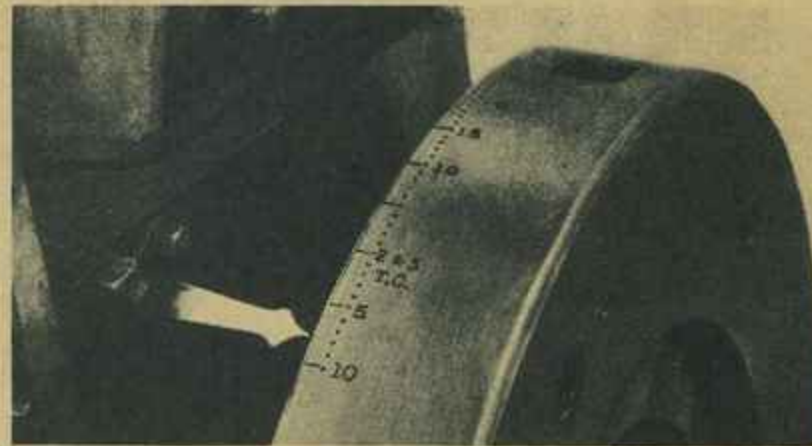

FIG. L-1

### 15. VALVE TIMING

The valve timing may be determined from the markings stamped on the flywheel, as illustrated in Fig. L-1. The top center of each piston or pair of pistons is marked with the piston numbers (No. 1 is on the timing gear end of the engine), and degree marks are stamped on each side. The graduations are by degrees, and each fifth degree is marked with a numeral. The correct valve timing is given in the following table, and is stamped on the name plate of each engine.

Starting Air Valve Opens	- - - - -	$10^{\circ}$	A.T.C.
" " " Closes	- - - - -	$55^{\circ}$ to $60^{\circ}$	B.B.C.
Inlet Valve Opens	- - - - -	$10^{\circ}$	B.T.C.
" " Closes	- - - - -	$35^{\circ}$	A.B.C.
Exhaust Valve Opens	- - - - -	$35^{\circ}$	B.B.C.
" " Closes	- - - - -	$5^{\circ}$	A.T.C.
Fuel Spray Valve Opens	- - - - -	see engine name plate	
" " Closes	- - - - -	see engine name plate	

### 16. INLET AND EXHAUST VALVE TIMING

After the correct relation between the crankshaft and camshaft has been determined as described in Paragraphs 11 and 12, the push rods must be adjusted as follows: (See Section O for timing of fuel spray valve.)

- (a) Spot piston at  $10^{\circ}$  B.T.C. at the end of the exhaust stroke.
- (b) Adjust inlet push rod so that valve is just opening.
- (c) Spot piston at  $5^{\circ}$  A.T.C. on the suction stroke.
- (d) Adjust exhaust pushrod so that valve is just closing.
- (e) Check clearance between valve stems and rocker rollers. The cams are designed for  $1/32$ " clearance with the valves set as above and with the engine cold, but this will vary somewhat due to manufacturing tolerances. When making the adjustments aim at the opening and closing points but keep the clearances between  $.020$ " and  $.040$ ", varying the opening and closing points slightly if necessary. Excessive clearances mean a noisy engine and increased wear on parts. Insufficient clearances prevent valves from seating properly, with consequent blowby and destruction of valves and seats.
- (f) Check and record closing point of inlet valve and opening point of exhaust valve. These points should fall within  $5^{\circ}$  of the position given in the timing table.
- (g) Adjust and record valve timing for the other cylinders as above.

### 17. STARTING AIR VALVE TIMING

- (a) Block the starting valve wedge shaft in its starting position.
- (b) Spot piston at  $10^{\circ}$  B.T.C. at the end of the compression stroke and adjust the pushrod so that the valve is just opening. Check the closing point, which should fall within  $5^{\circ}$  of the position given in the table. (See Paragraph 15).
- (c) Adjust and record starting air valves for the other cylinders as above.



FUEL SUPPLY SYSTEM

The complete fuel system may be conveniently divided into two parts, the fuel supply system and the fuel injection system. The fuel supply system is made up of the fuel transfer pump and the fuel day tank and filter; while the fuel injection system includes the high pressure fuel pump, the fuel rail, or accumulator, the fuel pressure regulating valve, the fuel spray valves, and the necessary connecting tubing.

1. IMPORTANCE OF CLEANLINESS IN FUEL HANDLING

The high pressure fuel pumps and fuel spray valves have been referred to as the heart of the Diesel engine and the proper functioning of these parts is necessary for the successful operation of the engine. These pumps depend upon lapped plungers working in cylinders with clearances measured in hundred thousandths of an inch and it is vital that the fuel entering these parts be kept free of any grit or foreign matter. The engine is equipped with a filter and a strainer for this purpose but it is also necessary for the operators to use every possible care in getting clean fuel oil and in keeping it clean until it is delivered to the engine. Fuel tanks and piping should be thoroughly cleaned when installed and should be kept covered at all times.

The fuel filter should be periodically cleaned and serviced according to the detail instructions given in Paragraph 3. The best filters obtainable will be useless if dirt is introduced into the fuel after it has passed through them, and it is therefore of great importance that every effort be made to protect the fuel pipes after the filter during repairs and overhauls. Cleanliness in handling fuel, piping and injection equipment is of vital importance and will pay good dividends in trouble-free operation. Many times mysterious and expensive pump and fuel spray valve troubles have been traced to careless handling of fuel and carelessness in storing and installing spare parts.

2. FUEL TRANSFER PUMP

The fuel transfer pump, which is mounted on the gear casing just below the governor, is illustrated in Fig. N-1. It is an internal gear type pump, similar to the lubricating oil pump, and is driven from the camshaft gear.

Referring to Fig. N-1, the fuel pump assembly, consisting of pump (4), adapter (3), and bearing (2) is bolted to the end of the gear casing. The bearing is located and doweled to the gear casing to allow .004" - .006" backlash between drive gear (1) and the camshaft gear. End clearance for the pump rotor should be from .001" to .003", and is determined by the thickness of gasket (7). If replaced, measure the old gaskets with a micrometer and replace with exactly the same thickness. The pump shaft rotates on bronze bushings pressed into the bearing and adaptor, and if replaced the new bushings must be reamed to .6250" - .6255" diameter after pressing in and with the two pieces bolted together. The bushings must be located in the bores in accordance with the dimensions given in Fig. N-1 in order to allow the correct space for oil seal (5). The two bushings in bearing (2) are pressure lubricated from the engine oiling system and the bushing adjacent to the fuel pump is lubricated by fuel oil. The oil seal prevents leakage of fuel along the shaft, and any slight leakage past the seal drains off through hole (6). This connection may be piped off to a drain pan if desired, but should never be plugged, as the fuel oil may then be forced through into the engine and will dilute the lubricating oil.

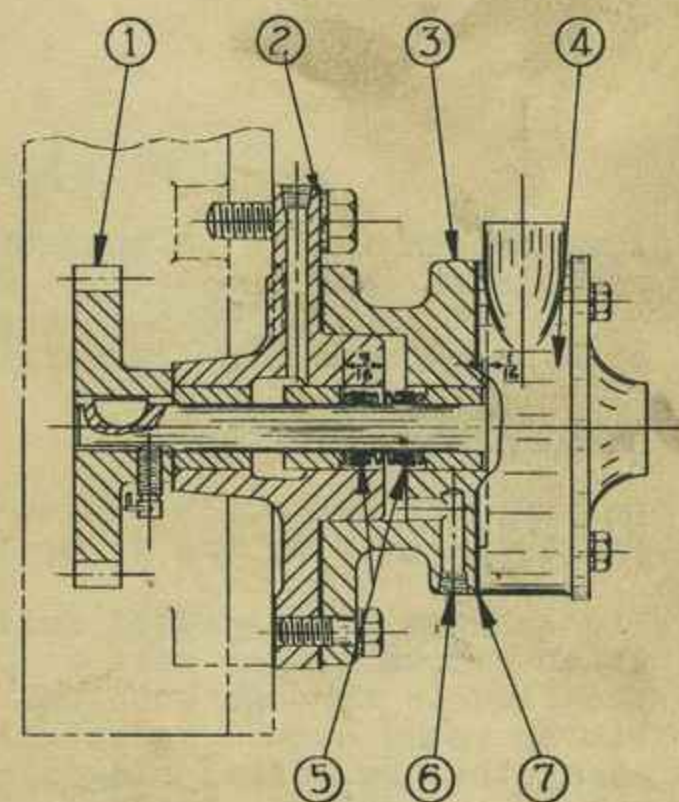

FIG. N-1

3. FUEL OIL DAY TANK AND FILTER

The fuel oil day tank and filter are shown in Fig. N-2. A continuous flow of fuel oil from the fuel transfer pump enters the unfiltered fuel compartment (4) through tube (1). The metal edge type fuel filter (2) is mounted in the side of tank (6). It has .003" spacing and is provided with a cleaning knife (3), operated by handle (8), which scrapes the dirt and muck off the outside of the cleaning spool. The handle should be turned every four or five hours, and should always be turned immediately after stopping the engine, as the dirt can then settle freely through the



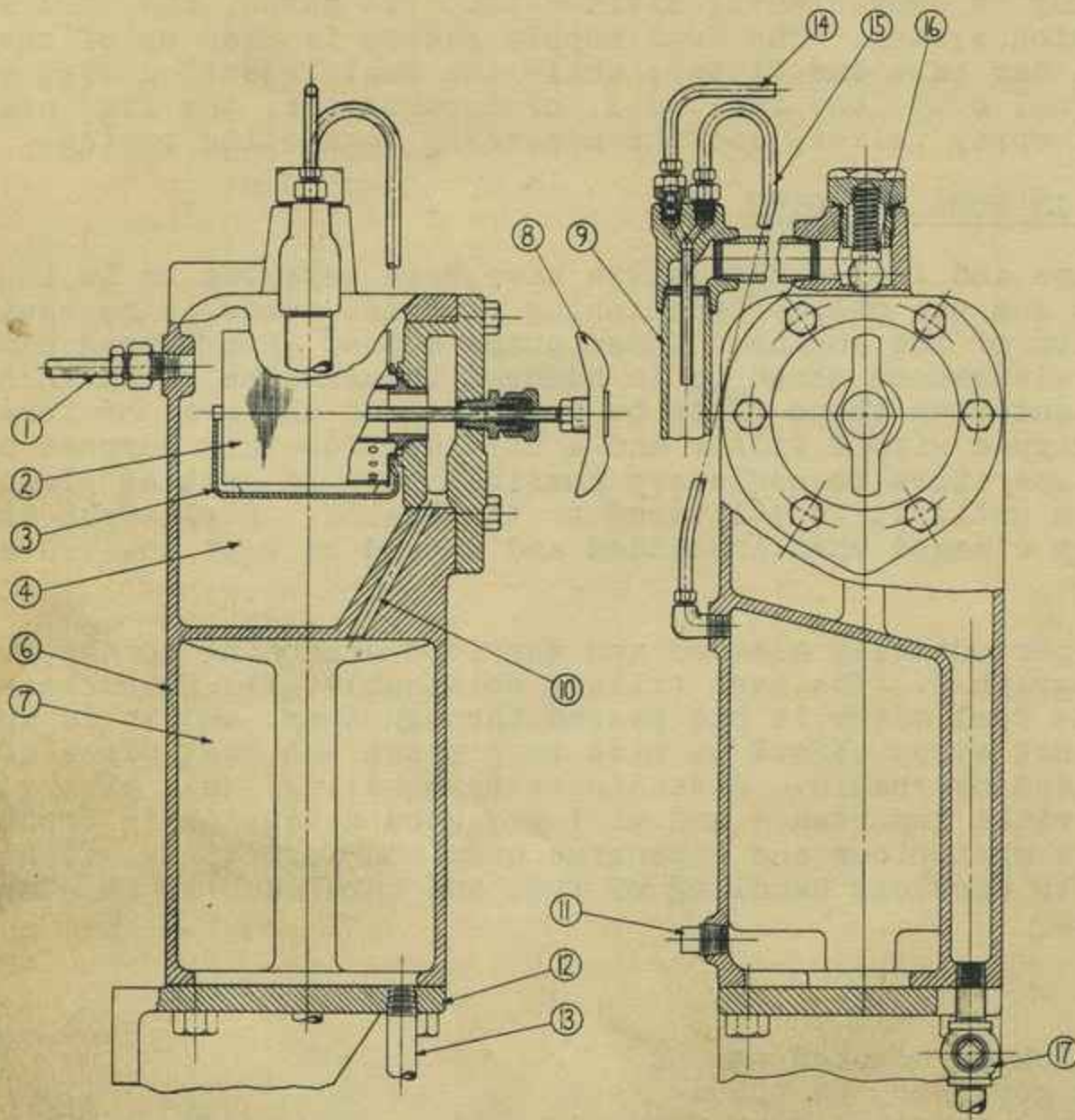

FIG. N-2

when the engine is in operation. When the engine starts the air in compartment (7) escapes through tube (15). The pressure in filtered fuel compartment (7) assures a continual flow of fuel through tube (15) into the overflow pipe, with no possibilities of reverse flow of unfiltered fuel from the overflow pipe to compartment (7).

#### 4. FUEL FILTER (SPECIAL)

On some engines built to government requirements the fuel day tank with built in filter is omitted and a Purolator duplex metal edge type filter is used instead.

The special filter is of full duplex construction with built in switch-over valve which allows either unit to be cut out for cleaning. When the handle is vertical the flow is through both units. The filtering element is made up of a flat metal ribbon wound around a central spool, adjacent layers being slightly separated from each other by raised ridges running across the ribbon. The successive layers of the ribbon are spaced .001" apart and it is these spaces that form the filtering medium, the fuel oil flowing through the spaces and leaving the dirt on the outside of the spool. The elements are made double, that is with two concentric filter spools to conserve space. The necessary cleaning interval for the elements will depend upon the fuel used and will be determined by experience. Once a week is suggested, but this may be altered to suit conditions. The elements should be removed for cleaning and thoroughly washed out in clean fuel oil or cleaning solvent and then blown out with compressed air.

quiescent fuel. The dirt and sediment collects in the sludge compartment at the bottom of the tank, and should be drained off through cock (17) at frequent intervals. This may be done to advantage when the engine is running, the pressure in compartment (4) assuring thorough cleaning.

After passing the filter the fuel flows through hole (10) into the clean fuel compartment (7), and then to the high pressure fuel pump through pipe (13). This pipe is screwed into mounting bracket (12) which forms the bottom of the tank. Compartment (7) can be drained by removing plug (11). The excess fuel from the transfer pump passes through relief valve (16) and returns to the service tank through overflow pipe (9). The relief valve maintains a pressure of 6 lbs. per sq. in. in the filtered fuel compartment. When the high pressure system of the engine is being primed air is admitted to compartment (7) through tubes (14) and (15), allowing the fuel to flow to the priming pump. The check valve in tube (14) permits sucking air when priming and prevents escape of fuel oil



FUEL INJECTION SYSTEM1. FUEL INJECTION SYSTEM

The common rail fuel injection system used on the Atlas engines is one of the most rugged and reliable of the various systems in use on modern Diesel engines. Like any good piece of machinery it must be kept in proper adjustment and repair, however, and the satisfactory operation of the engine is more dependent on the proper functioning of the injection system than on any other part of the equipment. It is therefore covered in some detail in the following description, and it is particularly recommended that careful attention be given to this section and that the instructions given herein in regard to adjustments etc. be very carefully followed at all times.

Briefly described, the common rail injection system consists of:

- (a) A high pressure pump capable of developing several thousand pounds pressure, and with a capacity in excess of the fuel requirements of the engine.
- (b) The accumulator or rail to which fuel is fed from the high pressure fuel pump and from which high pressure lines lead the fuel to the spray valves.
- (c) The mechanically operated spray valves, one in each cylinder head.
- (d) Mechanical means for opening the spray valves at the proper time in the piston cycle and for holding them open the length of time necessary to inject the exact amount of fuel required to carry the load that the engine is pulling.
- (e) A pressure regulating or bypass valve, for the purpose of controlling the pressure in the injection system and bypassing the fuel delivered by the pump in excess of the engine requirements.

2. HIGH PRESSURE FUEL PUMP

The high pressure fuel pump has two lapped plunger type pumps, actuated from a crankshaft by means of connecting rods and cross heads. The unit is enclosed in a housing which is bolted to the gear casing on the manifold side of the engine. The drive gear on the end of the crankshaft meshes with the intermediate camshaft drive gear, and the housing is positioned and doweled to the gear casing to allow .004" to .006" backlash in the gears. A small hand operated plunger is also built into the pump, and is used for priming the high pressure fuel system prior to starting and to build up pressure in the system when timing the engine or testing the spray valves.

The construction is illustrated in Fig. 0-1. Crankshaft bearings (1) and (6) in either end of the housing are separate castings, bolted to the housing and bronze bushed for the bearing surfaces. If replaced the bushings must be reamed to 1.6250" to 1.6255" and 1.5000" to 1.5005" diameter, after pressing in. The larger dimension is for the bearing in the gear end, which also carries the mounting flange by which the unit is attached to the gear casing. Both bearings are pressure lubricated from the engine force feed system, and oil holes through the crankshaft carry oil to the crank pin bearings. The connecting rods are also drilled, and feed oil up to the needle bearings at the wrist pins. A drain hole in the gear end bearing

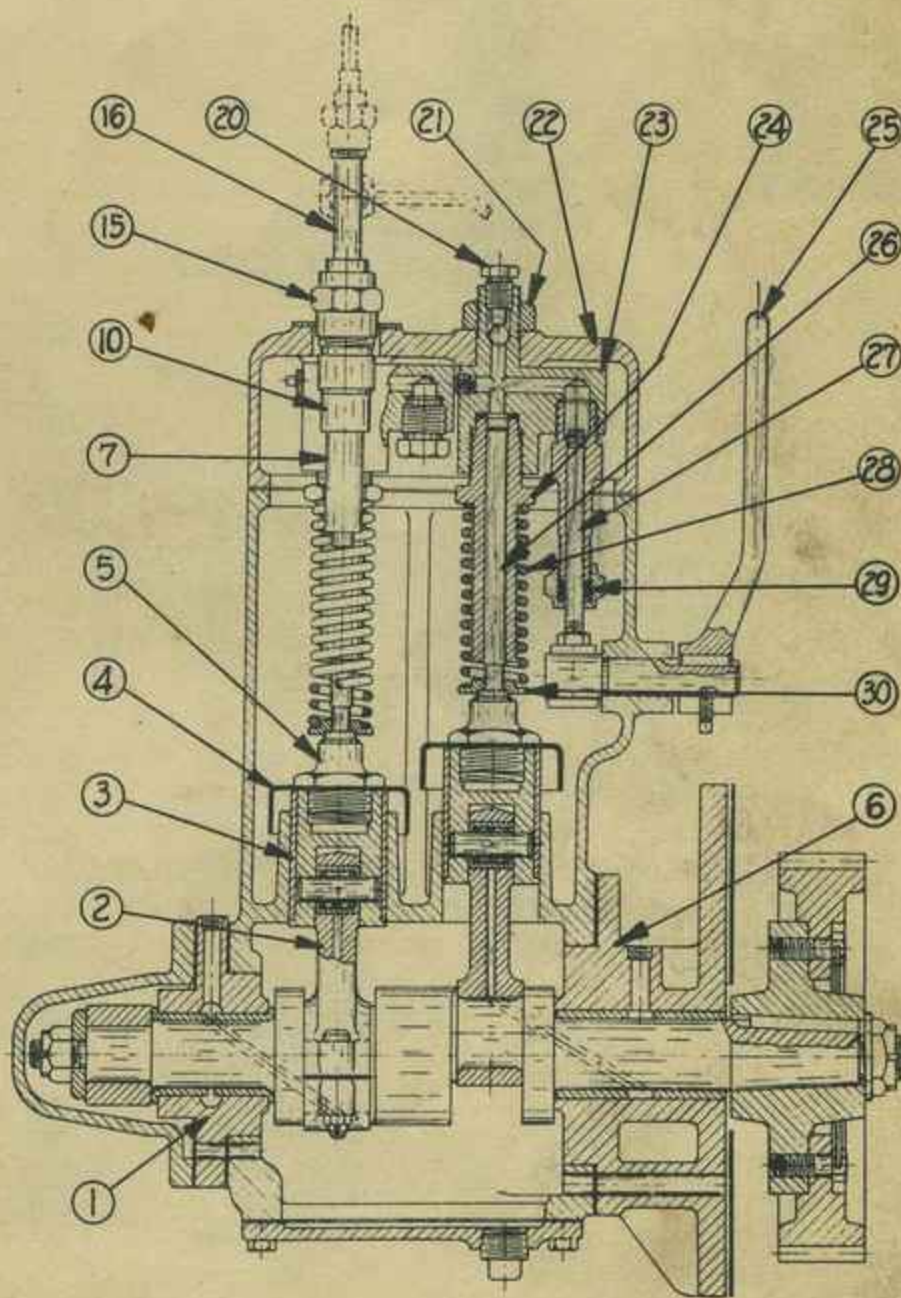

FIG. 0-1



returns the oil to the engine. Fuel leakage from the pumps collects in the upper compartment of the pump housing and is led off through a drain hole.

Bronze connecting rods (2) have .0015" to .0025" clearance on the crankpins and .004" to .008" side clearance. Bearing adjustment is by shims. If the wrist pin bearings are replaced they must be pressed into the rods with the oil holes on the horizontal axis. The replaceable bronze sleeves (3) on the cross heads have from .002" to .004" clearance in the guide bores in the housing. They are held in place by shoulders at the bottom of the cross heads and by oil guards (4) and plugs (5) at the upper ends. Lubrication is from the wrist pins.

The two identical pump units are shown in enlarged detail in Fig. 0-2. Each consists of head (23), plunger (26) and barrel (24) and valve cage (10). The heads are mounted in housing cover (22) and are retained by nuts (21). The pump barrels and valve cages are screwed into the heads. Straight threads are used on the pump barrels, copper gaskets making the seal, and taper pipe threads are used for the cages. The priming pump unit is also mounted in one of the pump heads, the corresponding hole in the other head being closed with a plug. Discharge tee (16) is used on one of the pumps only and the vertical outlet connected to the accumulator and the horizontal outlet to the discharge of the other pump.

The pump plungers are held down against the cross heads by springs (28), retained to the lower ends of the plungers by horseshoe washers (30). The plungers are raised by the cross heads on the discharge stroke and are returned on the suction stroke by the springs. The plungers and barrels are lapped together in matched pairs and are not interchangeable. Always use care to prevent mixing them and to prevent damage to the lapped surfaces. If either piece becomes scored or damaged both must be replaced. Always wash parts thoroughly in clean solvent or fuel oil and lubricate with clean engine oil before replacing. Avoid touching the lapped surfaces with the hands, and avoid entering the plunger into the barrel unless both are absolutely clean and lubricated. Always keep spare pumps well greased and wrapped in waxed paper.

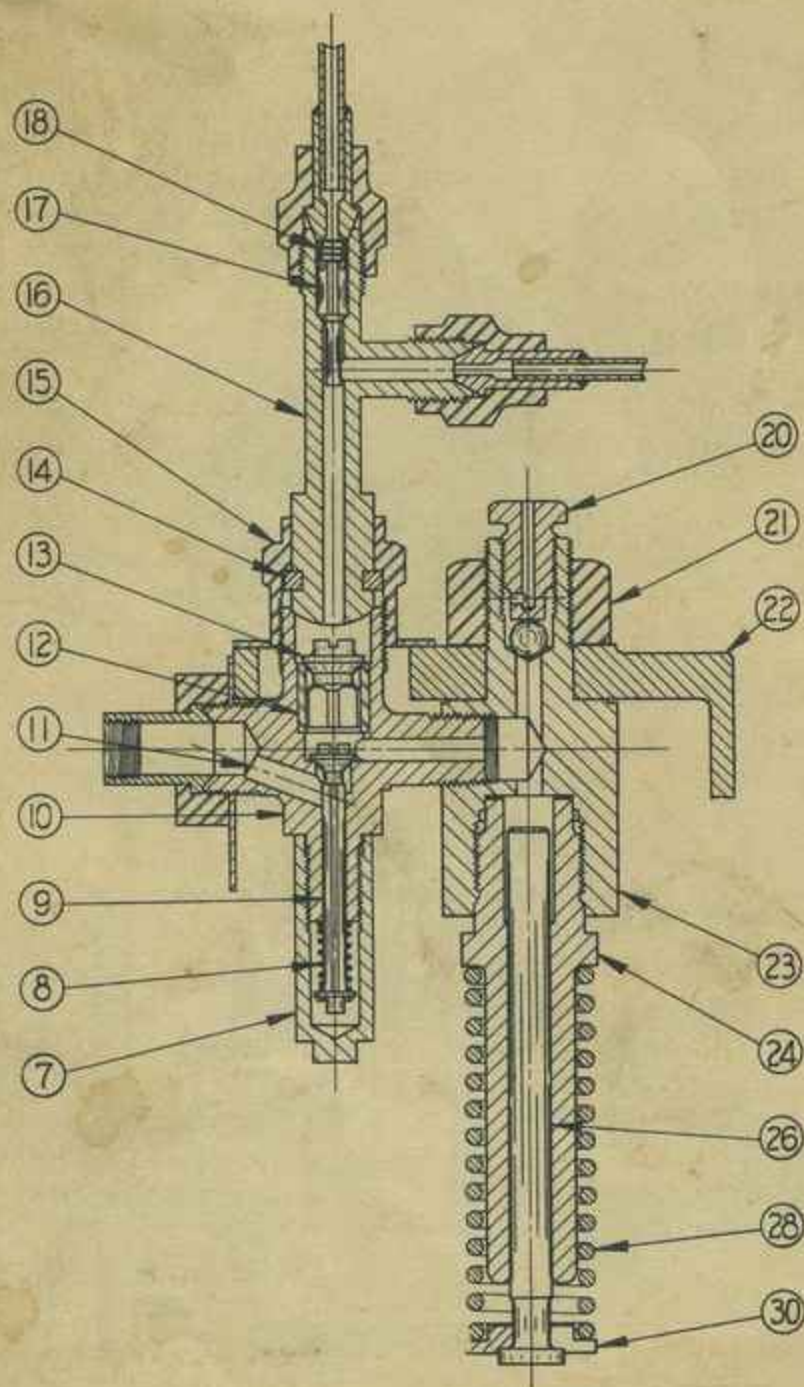

FIG. 0-2

When dismantling the pump, housing cover (22) with the pump assemblies attached may be removed as a unit. Hold the pump plungers in place as the unit is lifted, as they will drop out of the barrels when free of the cross heads and may then be damaged. The lower end of the priming pump plunger may be disengaged from its operating fork as the unit is raised.

Suction valves (9) and discharge valves (13) are located in valve cages (10), one to each pump unit, as previously mentioned. (See Fig. 0-2.) Fuel under a slight head from the transfer pump and day tank unit is supplied through port (11). The suction valve is guided and seated directly in the cage, and valve spring (8) is enclosed by bonnet (7), which prevents external leakage. A flat along one side of the valve stem permits displacement of the fuel in the bonnet space as the valve stem moves in and out. The discharge valve is fluted and is guided in a hardened steel seat (12), which is pressed into the valve cage. The valve lift is limited by the lower end of discharge fitting (16).

Referring to Fig. 0-2, both suction and discharge valves are accessible through the discharge opening after removal of discharge fitting (16), which is secured to the valve cage by retaining nut (15) and split ring (14). Valve leakage as evidenced by low or erratic fuel pressure can usually be stopped by lapping the seats lightly with fine grinding compound, but if this does not correct the difficulty the entire valve and cage assembly should be replaced. Be sure that all traces of grinding compound are thoroughly washed off at completion of grinding operation. If the lower end of the discharge fitting above discharge valve (13)



shows signs of heavy hammering this is usually due to discharge valve seat (12) being loose in the cage. The cage and seat must then be replaced. An auxiliary discharge valve (17), located in the discharge valve fitting makes the pump less sensitive to leakage of the regular valve. It is held against its seat by spring (18), which bears against the end of the fuel tube.

Referring to Fig. O-1 priming pump plunger (27) is actuated by linkage from hand lever (25). (See Fig. O-1) The upper end of the plunger is formed as a valve head, which engages a seat in the barrel, preventing leakage when the engine is in operation. Leakage may be stopped by lapping lightly with fine grinding compound. Packing (29) at the bottom of the barrel seals the plunger when the pump is in use. Vent plugs (20) in each valve head should be loosened when priming the engine to allow the escape of air entrapped in the fuel system. Tighten the plugs as soon as solid fuel appears.

The high pressure fuel pump has been designed to give long trouble-free performance provided that it is given reasonable care. Water, dirt and other impurities in the fuel will materially shorten the life of the plungers and barrels. The normal working pressure is 4000 to 5000 lbs. per square inch but the pump is capable of building up pressures far in excess of this figure. Carelessness in the care of the pressure regulating valve, may cause it to become ineffective, and the resulting high pressure may injure the pump and also damage other parts of the injection system. It is consequently important that the fuel pressure regulating valve be kept in good operating condition so that excessive pressures may not be built up, with consequent damage to the pumps and other parts of the injection system.

### 3. ACCUMULATOR

To prevent large pressure fluctuations in the injection system each time a spray valve opens or a pump delivers fuel the volume of the system is increased by the addition of an accumulator. The fuel in the accumulator, due to its compressibility, tends to maintain a constant pressure in the fuel system without appreciable fluctuations. The accumulator is located in the push rod compartment of the cylinder block, just below the starting air manifold. It is made of  $2\frac{1}{4}$ " O.D. seamless steel tubing with plugs welded in each end. The accumulator also serves as a "rail" distributing the fuel to the various spray valves.

### 4. INJECTION TUBING

All of the high pressure lines used in the injection system are seamless steel tubing. The ends are formed by brazing union sleeves to the tubing, and union nuts fasten these ends to the various fittings.  $1/4$ " O.D. x .065" wall thickness tubing is used. A high grade tubing is used, made especially for this service, and standard seamless steel tubing should never be substituted.

The importance of keeping the injection lines clean cannot be overemphasized. When an injection line is removed from the engine the open ends should be covered with clean paper which should not be removed until the tubing is to be placed on the engine again. If there is any doubt as to the cleanliness of an injection line it should be thoroughly cleaned before installing. To clean a line it should be washed repeatedly in cleaning solvent or gasoline and should be blown out with an air hose between each washing. This cleaning process should be carried on until there is no uncertainty as to the cleanliness of the tubing.

The high pressure fuel tubes from the pump to the accumulator and from the accumulator to the pressure regulating valve are carried through the cylinder block wall by special through type elbow fittings, with union tube connections at each end. Isolating valves in each of the injection lines from the rail to the spray valves permit cutting off the fuel to any cylinder. They are gland packed needle valves, located near the top of the cylinder block, with the stem and stuffing box projecting through to the outside of the block. The tubes from the accumulator lead to the lower connections of the valves and extension stems screwed into pipe tapped holes in the tops of the valves project up into the cylinder heads. Injection tubes lead from the ends of these stems to the spray valves. A double isolating valve is also provided, connected into a line leading from the ends of the fuel accumulator. One connection leads to the fuel pressure gage, and the other provides an outlet for testing spray valves, as described in Paragraph 8.

### 5. FUEL PRESSURE REGULATING VALVE

Injection pressure control is afforded by the adjustable pressure relief valve. This valve is of the by-pass type in which the opposing forces of a spring and the fuel pressure acting on the stem of a needle valve maintain constant fuel pressures. If the pressure starts to drop the spring closes the needle slightly reducing the amount of fuel by-passed with the result that the pressure is held constant.



Referring to Fig. 0-3 the regulating valve is built around valve body (7). The hardened steel valve seat (8) is held between the body and adapter stud (9) which screws on the bottom of the body and through which passage (18) allows the by-passed fuel to escape. Fuel inlet elbow (16) is threaded into the side of the body, supplying fuel to the annular space around the reduced section of the valve stem (17). The top of the body is bored to receive stem packing (15) and packing gland (14). Screwed to the top of the body is relief valve spring cage (5). This cage is screwed down upon the drain cup holding the latter in place against a shoulder on the body.

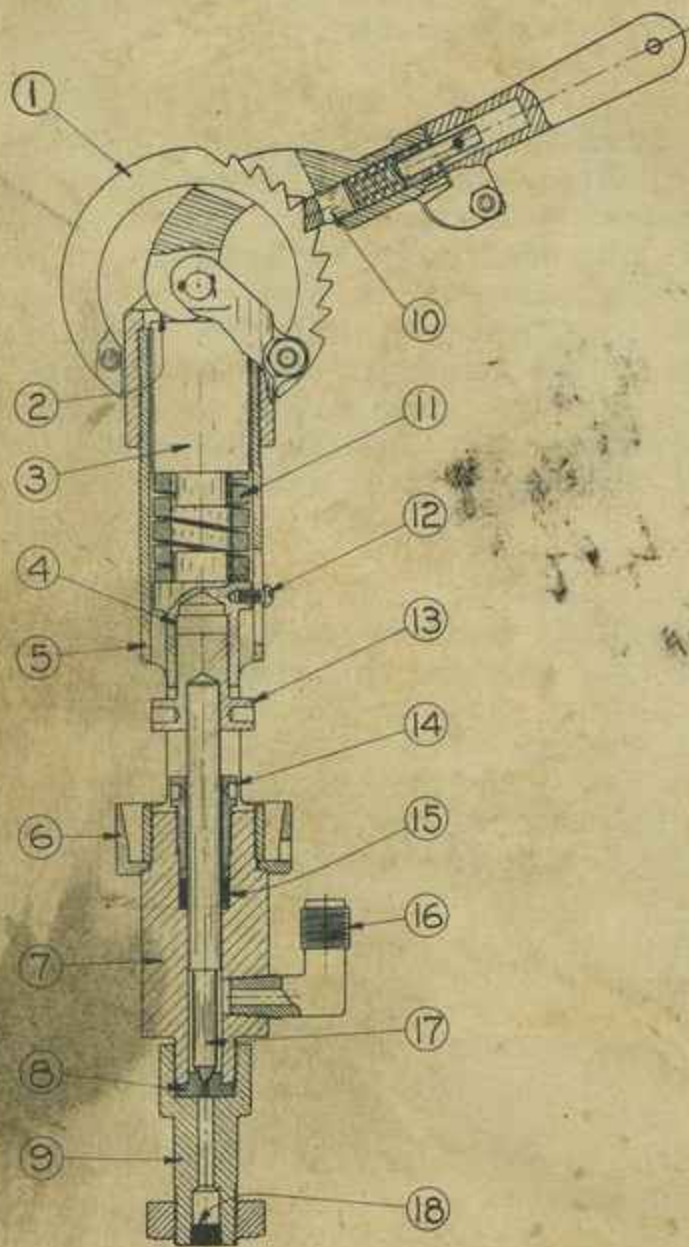

FIG. 0-3

cleaning the valve and its seat. Occasionally it may be necessary to lap the needle and its seat to prevent excessive by-passing and a low fuel pressure. After performing this operation all traces of grinding compound should be carefully washed off before the valve is reassembled.

## 6. SPRAY VALVES

The purpose of the spray valve (or fuel injection valve) is to meter the fuel accurately, to deliver it precisely at a definite moment, in a definite time into the combustion chamber in the form of a finely atomized spray. It might be stated that the successful operation of the engine depends upon the proper functioning of the spray valves more than on any other item. If the engine does not perform properly and the exhaust is smoky, the functioning of the fuel valves should be checked first of all. In the great majority of cases servicing the fuel valves and making them function properly corrects the trouble.

Fundamentally, the spray valve is a heavily spring loaded needle valve. Referring to Fig. 0-4 the seat of the needle valve is incorporated in the tip or nozzle (1) just above the entrances to the spray orifices. The lower end of valve body (4) is counterbored to receive the end of the spray valve tip. A shoulder on the spray tip (1) which is centered in the counterbore, is held securely against the lower end of the body by nut (2). Valve assembly (3) is made up of two sections. The lower section has a conical end which is ground to the seat in the spray valve tip. This lower stem section is pressed into an extension (10) which in turn is screwed into an adjusting nut provided with a shoulder at the lower end. On top of the shoulder is mounted a ball type thrust bearing which is the lower retainer for spring (9). Upper spring retainer (12) screws into the upper end of valve spring



casing (13) which in turn is threaded to the upper end of valve body (4).

The flange used for clamping the valve is drilled and tapped to receive fuel elbow (6) which supports the small metal edge type filter (15). Fuel is carried from this point to the nozzle in the annular space surrounding stem (3). Leakage upward along the stem is prevented by packing (7) held between an upper and lower gland and secured by packing nut (8).

7. REMOVAL OF SPRAY VALVE FROM ENGINE (See Fig. 0-4)

- (a) Remove the two capscrews holding spray valve rocker bearing (43) in place, and remove the bearing and rocker assembly.

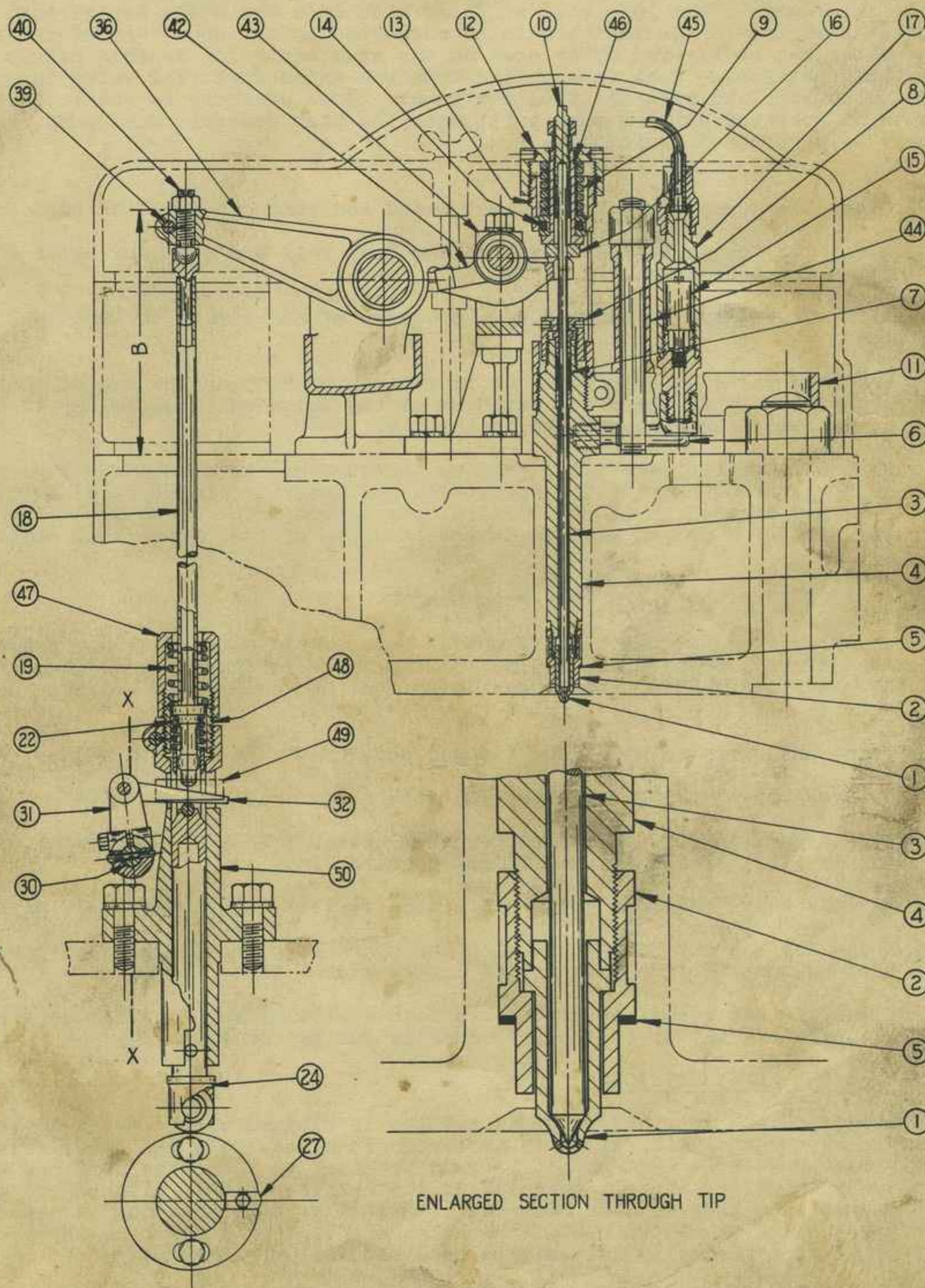

FIG. 0-4



## Section O

- (b) Disconnect the injection line (45) from the top of the spray valve filter.
- (c) Loosen the clamp nut and remove clamp (11) and bridge (44).
- (d) Remove the spray valve from the head. It may be necessary to work the valve loose by rotating it back and forth and in some cases to pry it upward with a bar to remove it. As the valve is lifted out of the head note whether copper gasket (5) remains in the hole or comes out with the valve.

### 8. TEST EQUIPMENT

All the parts for a spray valve test stand are included in the tool equipment supplied with the engine. The spray test clamp which holds the spray valve directly below the flanged section of the body should be mounted on some convenient location near the engine. The long stud supplied with this equipment screws into the outer end of the clamp. The test handle is supported on the upper end of the stud by a nut which can be screwed up or down on the stud until the desired height of fulcrum has been obtained. Fuel is supplied from the extra fuel rail valve through a length of tubing supplied with the tool equipment. Fuel pressure is obtained by means of the hand operated priming pump built into the high pressure fuel pump. To test a spray valve proceed as follows:

- (a) Clamp the spray valve in the test stand and connect it to the fuel rail.
- (b) Close all the isolating valves on the fuel rail and open the valve which supplies the test stand.
- (c) With the priming pump build up a pressure of about 2000 to 4000 lbs. per square inch.
- (d) Open the valve quickly three or four times by hitting the end of the test handle sharp blows with the fist, watching as the valve operates to see if a fine fuel spray comes out of each hole in the tip.
- (e) Wipe off the tip carefully, pump up the pressure to about 4000 lbs. per square inch again and operate the spray valve as described in step (d) until the pressure has dropped to about 2000 lbs. per square inch. Then watch the bottom of the tip for a period of time to see if drops of fuel form, indicating tip leakage.

### 9. DISASSEMBLY OF SPRAY VALVE (See Fig. O-4)

If the sprays are not uniform, if one or more orifices are entirely plugged up, or if drops of fuel form on the end of the tip after testing as described in step (e) of the preceding section, the spray valve must be taken apart and serviced. Proceed as follows:

- (a) Clamp the spray valve at the flanged section of the body in a vise.
- (b) Unscrew upper spring retainer (12) with a suitable pin or drift.
- (c) Loosen packing nut (8) and remove stem assembly (3 and 10) together with the retainer (12), spring (9) and thrust bearing (14).
- (d) Unscrew valve seat nut (2). Spray tip (1) will usually come off with the nut.
- (e) Drive the tip out of the nut with the punch supplied for this purpose in the tool equipment. Use care not to damage end of tip.
- (f) Clean the outer surface of the tip with a wire brush, dipping the tip into cleaning solvent or fuel oil frequently during the brushing.

### 10. CLEANING THE SPRAY ORIFICES

If the sprays are not uniform or an orifice is plugged up the holes in the spray tip must be cleaned. Again, if it is necessary to disassemble the spray valve for some other reason such as leakage, it is good practice to clean the orifices at the same time. It sometimes happens that all of the orifices become slightly clogged with the result that they deliver less fuel. Such a condition cannot be detected when the spray valve is tested but if the holes are cleaned every time service work is performed upon the spray valves this condition will be taken care of.

The cleaning of the orifices should be performed only with the music wire and pin vise supplied with the tool equipment, not with the ends of hat pins and other such



devices. If the original wire is lost obtain a piece of music wire of not more than .009" dia. for this purpose. Work the wire in and out of each orifice until the holes are clean. This operation should be performed carefully so that the orifice will not be deformed.

#### 11. CORRECTING SPRAY VALVE TIP LEAKAGE

Leakage of the spray valve is usually due to a small amount of dirt between the needle and the valve seat. Often this condition can be remedied by washing the tip thoroughly and cleaning the end of the valve stem. This procedure should be attempted first in all cases of valve leakage.

If, after washing the tip and spindle, drops of fuel still form on the bottom of the tip shortly after the fuel valve is sprayed, it will be necessary to reseal the valve by lapping. The procedure of reseating a tip is as follows:

- (a) Clamp the valve body in a vise horizontally.
- (b) Loosen spring retainer (12).
- (c) Apply a small amount of fine valve grinding compound to the end of valve stem (3).
- (d) Place the tip over the valve stem and insert it fully into the valve body.
- (e) Adjust retainer (12) so that the stem exerts a light pressure on the tip.
- (f) Oscillate the tip back and forth and rotate the spindle slowly. Be sure that the tip is held against the body as this operation is being performed so that the tip will be properly guided.
- (g) Repeat steps "c", "d", and "f", if necessary.

It should not be necessary to lap the tip more than two or three times to correct ordinary cases of leakage. However, if the seat in the tip has been badly damaged no amount of lapping will remedy the situation. In such instances a new tip should be installed. When installing a new tip the joint between the tip and the valve body must first be lapped. A small amount of fine valve grinding compound is applied to the upper face on the shoulder of tip (1). The tip is then installed in the end of the valve body and oscillated back and forth. The tip is held gently against the body as this operation is being performed. One light lapping process should be sufficient to produce a perfect seal between the tip and valve body. The tip is then lapped to the valve stem by the method described in this paragraph.

#### 12. VALVE PACKING ADJUSTMENT

Packing nut (8) should never be appreciably more than finger-tight. A small amount of fuel leakage past the packing is necessary for proper lubrication of the spindle. Too tightly adjusted packing will prevent this lubrication and will result in a scored spindle and sluggish valve action. If a spray valve leaks excessively along the spindle after the packing has been lightly tightened up the need for new packing or a new spindle or both is indicated.

#### 13. ASSEMBLY OF THE SPRAY VALVE - SPRAY VALVE "LIFT"

Referring to Fig. O-4, spring (9) must be adjusted to a certain tension in order to assure proper functioning of the spray valve. It is further important that the adjustment of all the spray valve springs be the same or that the "lift" on all the spray valves be the same. With "lift" as used in the following instructions is understood the lift which spring (9) will allow before its coils touch each other and prevent further upward movement of the valve stem. (The actual lift when the spray valves are operating in the engine is of course determined by the position of fuel wedge (32), the adjustment on pushrod (18) and cam (27). This actual lift is less than the "lift" as defined in this paragraph.) Proceed as follows to assemble the valve and adjust for proper "lift" (or opening tension):

- (a) Wet spindle (3) with clean fuel oil and slip it into position in the valve body.
- (b) Clean the spray valve tip and install it carefully on the valve body. Tighten valve seat nut (2) securely.
- (c) Screw down on spring retainer (12) carefully until the coils of spring (9) just touch. Be careful not to screw down so hard that valve stem (3) bends, rendering it useless. It is best to have the valve in the test stand when performing this operation and determine when spring (9) becomes solid by means of the test handle. When it is not possible to lift the spray valve stem by means of the test handle the spring coils are touching. The "lift" is then zero.
- (d) Unscrew spring retainer (12)  $3/4$  to  $7/8$  turns which will make the "lift"  $1/16$ ". The "lift" on all the valves should be between  $1/16$ " and  $5/64$ ".
- (e) Screw down on packing nut (8) until it is just finger-tight.



## Section O

(f) Test the functioning of the valve as described in paragraph 8.

### 14. ASSEMBLY OF SPRAY VALVE IN ENGINE

The spray valve is installed in the engine in the reverse order of its removal. Again referring to Fig. O-4, if copper gasket (5) is in the cylinder head merely lower the valve into position. If the copper gasket (5) was removed with the valve, the gasket can be held in position on the lower end of the valve by a thin coating of grease applied to the washer.

After installing the valve it will be necessary to reset the push rod as described in paragraph 18. After timing, in order to clear the cylinder of excess oil, always turn the engine over on air with the snifter valves open and with the fuel isolating valves closed.

### 15. SPRAY VALVE FUEL FILTERS

In addition to the fuel filter in the fuel day tank an individual filter (15) is supplied at each spray valve. The spray valve filters are of the metal edge type and have a spacing of .0015". They are installed in housing (17) which screw into the fuel inlet elbows at the spray valves. The frequency at which these filters will need cleaning will depend upon the quality of the fuel and the condition of the filter in the day tank. After disassembling the housings it will be possible to unscrew the filter unit. Wash each unit thoroughly in clean solvent or fuel and blow it clean with compressed air, being careful not to injure the windings when handling it.

### 16. SPRAY VALVE OPERATING MECHANISM (See Fig. O-4)

The spray valve is actuated through cam (27), lifter or cam follower (24), push rod (18), and rockers (36) and (42). Motion of the lifter is transmitted to the pushrod through wedge (32). The pushrod is held up free of the wedge by spring (22), so that, except during the time that the lifter is raised by the cam, there is clearance between the wedge and the pushrod. As can readily be seen in Fig. O-4, moving the wedge inward will decrease this clearance and the spray valve will open sooner, will lift higher, and will close later. Moving the wedges outward produces the opposite results. The outer end of the wedge is pinned to lever (31), which is clamped to wedge shaft (30). This shaft is rotated by the governor, through connecting linkage. The governor thus moves the wedges in and out as it operates under fluctuations in the engine speed, and so exercises complete control over the spray valves.

When the engine was tested at the factory, wedge levers (31) were adjusted to be parallel to each other and in line on wedge shaft (30) and were then clamped and pinned to the shaft. If new levers or a new wedge shaft are installed it is important that they be lined up in accordance with the above. The position of the fulcrum of wedges (32) for the full load full speed position (wedges fully in) should be about 1/4" inside the vertical line X-X through the center of the wedge shaft. It is determined by stop (49) which is bolted to one of the lifter guides and which limits the motion of the fulcrum pin. The position of the wedge fulcrum for idling at low speeds should be as shown in Fig. O-4, that is about 1/4" outside of line X-X. In other words line X-X should divide the total movement of the wedge fulcrum into two approximately equal parts.

Levers (36) on all cylinders should be parallel, and should be adjusted so that the dimension "B" in Fig. O-4 is approximately 7-1/32 inches. This adjustment is made by locating spray valve spindle sleeve (46) on the spindle extension (10). Back out adjusting screw (40) so that rocker (36) is free of the pushrod. Hold rocker (36) up so that the forked end of rocker (42) is bearing firmly up against washer (16) (do not lift with sufficient force to open the spray valve). Screw sleeve (46) up or down as required to locate rocker (36) in the desired position. Secure adjustment with the jam nut provided.

Buffer spring (19) positions the push rod relative to the lifter and assists spray valve spring (9) in returning part of the operating mechanism as the spray valve is being closed. The buffer spring assembly is permanently made up at the factory. Sleeve (48) is screwed into cage (47) to produce correct tension on spring (19) and the two parts are then welded together. The complete assembly is screwed in the top of lifter guide (50) and clamped after it has been properly adjusted. As the buffer spring assembly is screwed down spring (19) forces the pushrod downward against the weaker spring (22) and brings the end of the push rod closer to the wedge and lifter. Proper adjustment of the buffer spring assembly is as follows:

(a) Bar the engine until the fuel cam follower is on the base circle of the cam.



- (b) Set the wedge shaft and wedges in full load position (wedges "fully in" as determined by the governor weights being fully in) and unscrew cage (47) until there is clearance between the lower end of the pushrod and the upper face of the wedge.
- (c) Slowly screw down cage (47) and at the same time move the wedge back and forth sideways with fingers.
- (d) As soon as the wedge is felt to tighten unscrew the cage one-half turn and lock it in this position with the clamping screw.

NOTE: When timing the spray valves as described in the following the buffer spring assembly should always be unscrewed about one or two turns. When timing is completed adjust the buffer spring in accordance with instructions in this paragraph.

#### 17. SPRAY VALVE TIMING (See Fig. O-4)

The timing procedure described in the following is for a spray valve opening of  $6^{\circ}$  B.T.C. (Before Top Center) and a spray valve closing of  $20^{\circ}$  A.T.C. (After Top Center). The proper spray valve timing to use is stamped on the engine name plate and should always be followed. (The standard valve timing is  $6^{\circ}$  -  $20^{\circ}$ . However, these timings are somewhat modified to suit special conditions of service.) If the timing on the name plate differs from  $6^{\circ}$  -  $20^{\circ}$  opening and closing the following instructions should be modified accordingly. Proceed as follows:

- (a) Unscrew all buffer Spring Cages one or two turns. Shut off all the isolating valves in the fuel rail except for Number 1 cylinder.
- (b) Be sure that wedges are in the full load position ("fully in") as determined by the governor weights being against their inner stops. (Normally the wedges will be "fully in" when the engine is shut down but it is well to check this point.)
- (c) Spot Number 1 cylinder at  $7^{\circ}$  A.T.C. on the power stroke. (Half way point between  $6^{\circ}$  B.T.C. opening point and  $20^{\circ}$  A.T.C. closing point.) Then unbolt and turn the fuel cam until the center of the toe is directly in line with the axis of the lifter. Clamp the fuel cam temporarily.
- (d) Set the crankshaft  $6^{\circ}$  B.T.C. on the compression stroke. Bar the engine up to this point in the direction of rotation.
- (e) Pump up a fuel pressure of about 1500 lbs. per sq. inch with the hand pump.
- (f) Slowly screw down on adjusting screw (40) (with clamp screw (39) loose), until the pointer on the pressure gauge drops indicating that the spray valve has opened. Tighten screw (39) and check the adjustment by backing the engine up a few degrees, pumping the fuel pressure up again and barring the engine slowly in the ahead direction until the pressure again drops. If the flywheel pointer is not at  $6^{\circ}$  B.T.C. readjust and check again.
- (g) Bar the engine over to  $25^{\circ}$  A.T.C. and again pump up the fuel pressure. Then bar the engine backwards slowly until the pressure drops. This point, which is the closing of the spray valve, should be  $20^{\circ}$  A.T.C.
- (h) If this point is past  $20^{\circ}$  A.T.C. too long a spray period is at hand. It will be necessary to advance the fuel cam slightly and repeat steps "d", "e", "f", and "g". If on the other hand the spray valve closes before  $15^{\circ}$  A.T.C., retard the cam slightly and repeat steps "d", "e", "f", and "g".
- (i) Repeat steps "c" to "g" on the remaining cylinders and record the spray valve timings.
- (j) Adjust the buffer springs as per instructions in paragraph 16. Note that buffer spring cages should always be unscrewed when spray valves are timed.

#### 18. BALANCING THE ENGINE FOR EQUAL LOAD ON ALL CYLINDERS

Theoretically, if the spray valves have been timed exactly and correctly (as outlined in the preceding paragraph) the amount of fuel injected in each cylinder should be the same. Consequently, the total engine load should also be equally divided between all the cylinders. Practically however, it is impossible to time all the spray valves exactly alike, and even if that could be accomplished manufacturing tolerances on such items as orifices in the spray valve tips, fuel cams, wedges, etc. are apt to affect the cylinder balance. The division of load between the various cylinders should consequently be checked after the engine is running, preferably at full load. Since the exhaust temperatures are proportional to the



## Section O

loads that the various cylinders are carrying the amount of fuel injected should be adjusted so that the exhaust temperatures for the various cylinders are alike, or nearly alike.

The amount of fuel injected and consequently the load carrying capacity of a cylinder may be changed by adjusting screw (40). Referring to Fig. O-4, clamp screw (39) should be loosened and the adjusting screw turned to affect the adjustment. It should be noted, however, that this adjustment will affect the spray valve timing. Therefore, the adjustment should not be appreciable and should not exceed one turn of the adjusting screw from the position obtained when timing the spray valve.

The proper procedure for balancing the engine can be summarized as follows:

- (a) Assuming that all the spray valves have been correctly timed it should be possible to balance the engine by turning adjusting screws one turn or less. Screwing down the adjusting screw will increase the exhaust temperature of the cylinder and vice versa.
- (b) If an adjustment of one turn is not sufficient the timing of all the spray valves should be checked and, if necessary, adjusted as described in Paragraph 17.
- (c) If the valve timing is found to be satisfactory or if, after making any necessary correction in the spray valve timing, a correction of one turn of the adjusting screw is still insufficient, defective combustion is indicated. This may be due to one or more spray tip orifices being plugged or to any of the defects dealt with under the heading "Smoky Exhaust" in the "Maintenance and Inspection" section.



GOVERNOR1. GOVERNOR

The flyball type governor is mounted on the timing gear casing on the operating side of the engine and is driven by the camshaft gear. It is illustrated in Fig. Q-1.

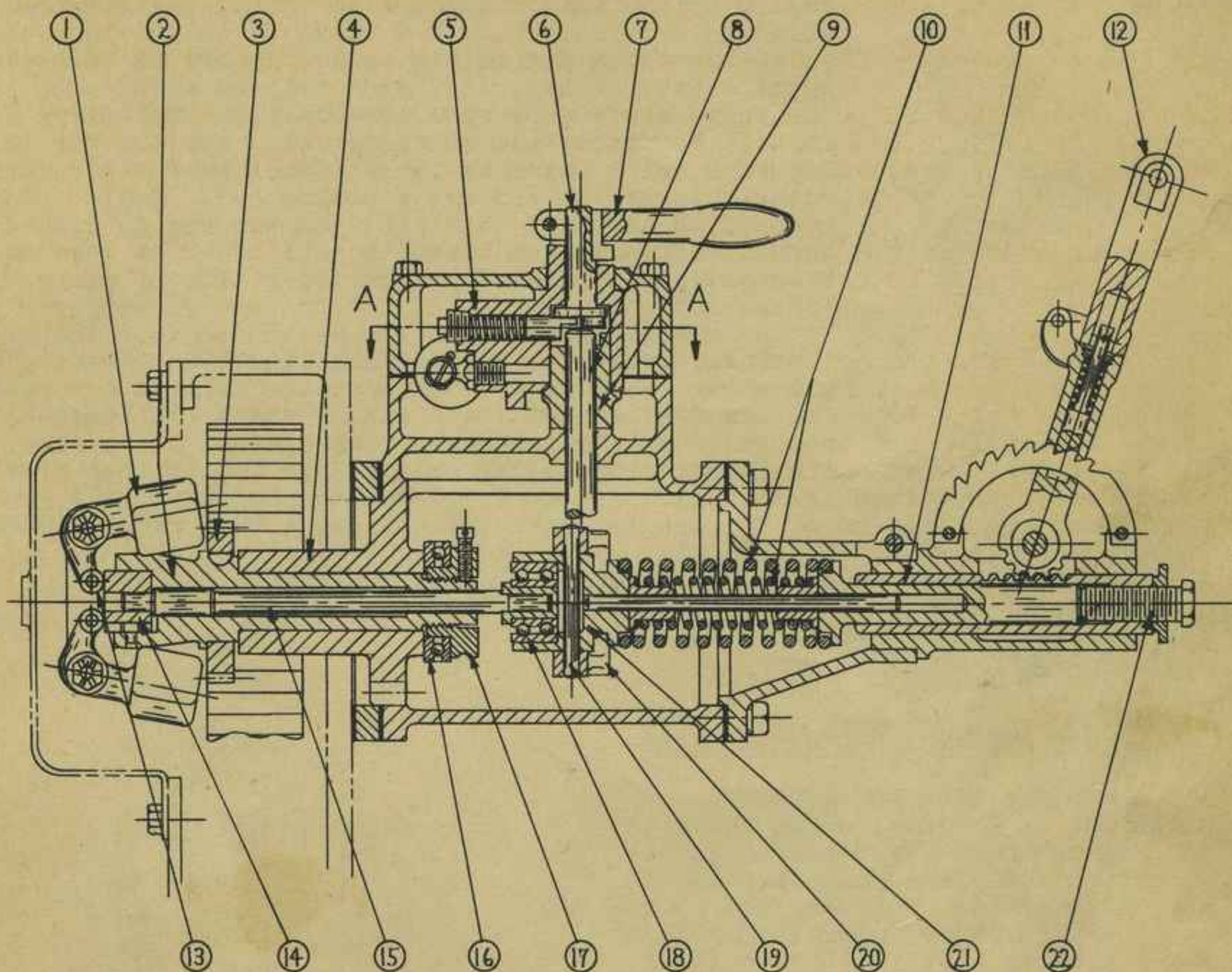

FIG. Q-1

Governor housing (4), which forms the governor bearing, is bolted and doweled to the gear casing. It is located to allow .004"-.005" backlash between governor gear (3), which is keyed and pressed on governor body (2), and the camshaft gear. Lubricating oil from the pressure pump is piped to the bearing through a drilled hole in the housing. Governor weights (1) are mounted on fulcrum pins in governor body (2) and carry hardened steel rollers (13) on riveted pins. As the flyballs tend to move out due to centrifugal force, the rollers bear against thrust plate (14) and transmit the force developed by the weights through quill rod (15), thrust bearing (18) and spring block (21) to governor springs (10). The thrust reaction is taken by bearing (16), which is secured to the governor body by threaded retaining collar (17). Thrust clearance is adjusted to .010" and the collar is locked by a set screw, secured in place by a locking wire through the head.

Spring block (21) follows the motion of the weights resulting from variations in engine speed. This motion is further transmitted by means of pin (19) and fork (20) to vertical shaft (8), to which fork (20) is clamped. Additional linkage connects vertical shaft (8) to the fuel wedge shaft to which each of the wedges are linked, thus completing the connection from the governor weights to the fuel wedges. The engine speed is controlled by varying the tension of the governor spring through hand lever (12) and rack (11). The lever is held in place by a latch which engages a toothed quadrant. A break mechanism in the handle permits moving the lever to the left, which reduces the spring tension. This allows the governor weights to move out, withdrawing the fuel wedges and reducing the engine speed. Conversely moving the control lever to the right increases the engine speed. Adjusting screw (22) controls the engine speed and should be set to give the desired full load speed



## Section Q

(see engine name plate) with the governor control lever in the last notch. The engine will then idle at the proper speed with the control handle in the first notch. The adjustment is secured by means of a lock nut.

### 2. STOPPING MECHANISM

The engine is stopped by rotating the hand lever on top of the governor housing. Lever (7) (See Fig. Q-1) is connected through a release mechanism to floating lever (5) on top of vertical shaft (8). Lever (5) is linked directly to the fuel wedge shaft. The release mechanism is shown in detail in Fig. Q-2 which is an enlarged section taken through line A-A in Fig. Q-1. It serves to break the connection between Lever (5) and vertical shaft (8), releasing the wedge shaft from governor control. Referring to Fig. Q-2 it will be noted that set screw (25) and plunger (23), both of which are mounted in lever (5), form a rigid connection between lever (5) and drive collar (9). Collar (9) is clamped to vertical shaft (8) and appears in Fig. Q-2 as the annular segment, the opposite ends of which bear against the diagonally milled flat on the lower side of plunger (23) (shown dotted in Fig. Q-2) and the end of setscrew (25). This is the normal position of the mechanism when the engine is running, levers (5) and drive collar (9) operating as a single unit. When lever (7) is pulled to stop the engine, eccentric (24) on the lower end of shaft (6) engages the end of plunger (23) and forces it back against its spring, out of engagement with collar (9). Lever (5) is then free to rotate

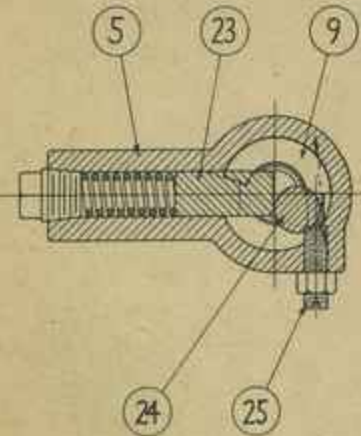

FIG. Q-2

clockwise without interference with collar (9). As stopping lever (7) is moved further the projecting end of the key in shaft (6) engages a boss extending from the top of lever (5) (not shown in Fig. Q-1) and thereafter lever (5) follows the motion of hand lever (7), pulling out the fuel wedges and stopping the engine.

### 3. LINKAGE - ATLAS GOVERNOR TO FUEL WEDGE SHAFT

The rod connecting the governor mechanism to the fuel wedge shaft is adjustable in the ball socket joints at either end. This adjustment should be set so that when the governor stopping lever (6) (See Fig. Q-1) is in the mid position of its stroke between full load and idling the connecting lever on the wedge shaft is vertical.

### 4. WOODWARD GOVERNOR & DRIVE

Complete instructions in regard to functioning, adjustments and servicing of the Woodward governor are contained in the pamphlet entitled "UG-8 GOVERNOR INSTRUCTIONS" by the Woodward Governor Co., Rockford, Illinois. This pamphlet will be found at the end of Section Q.

The construction of the Woodward governor drive and overspeed governor is illustrated in Fig. Q-3. The drive is contained in housing (9), which is bolted to the centerframe and gear casing and on which the governor is mounted. Drive shaft (10) rotates in a bronze bushing in one end of the housing and in a ball bearing in the other end. The bushing is pressure lubricated and if replaced must be reamed to 1.0000" to 1.0005" in diameter after pressing in and the oil hole must be drilled through. The reamed hole must be kept concentric

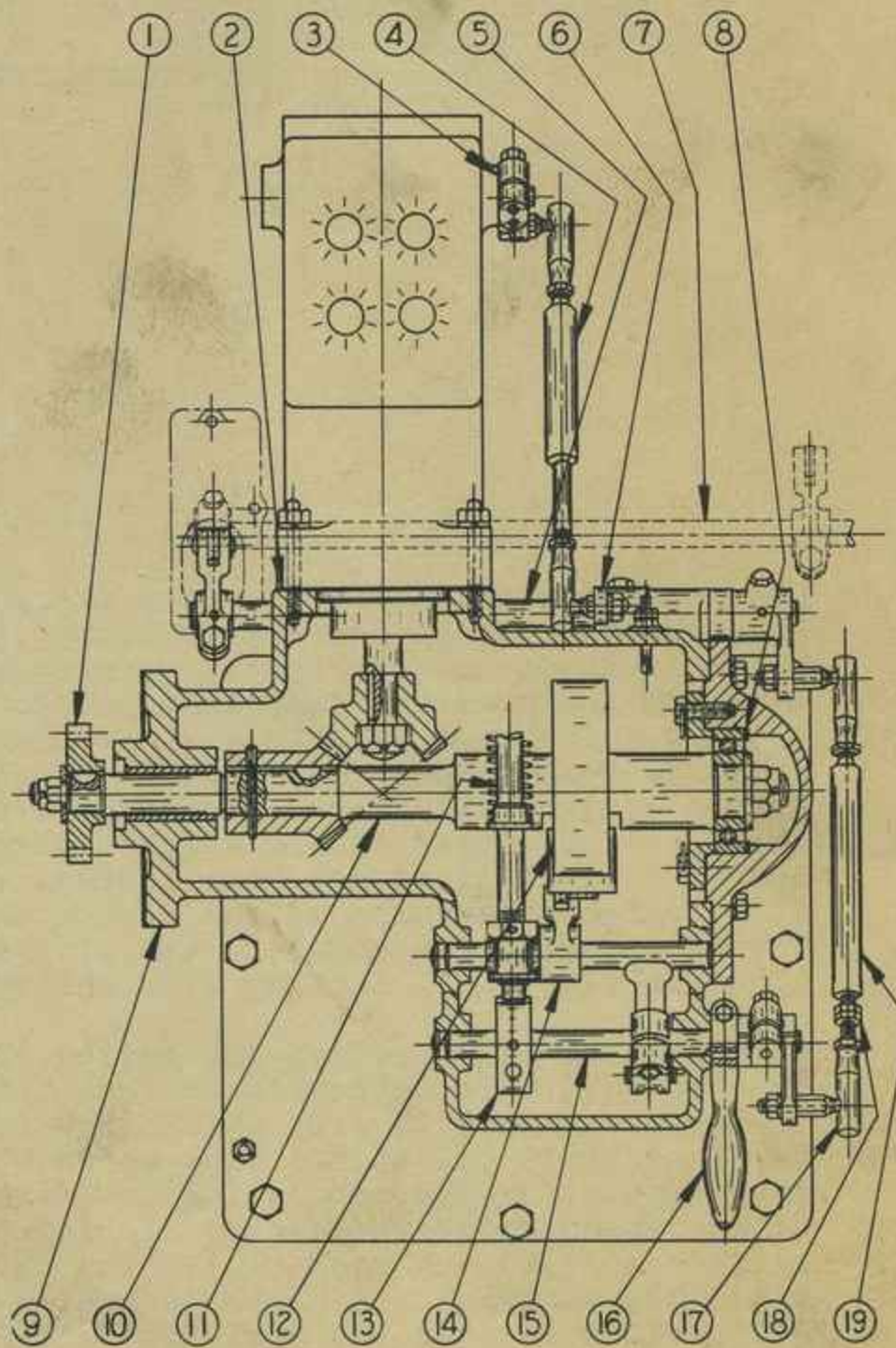

FIG. Q-3



with and square to the bore in the opposite end of the casing. Drive gear (1) mounted on the end of the shaft meshes with the camshaft drive gear. Clearance between the governor bevel drive gears is determined by shims (2) under the governor and shims (8) in the ball bearing housing. These shims are adjusted to bring the gear teeth in line and to allow approximately .004" backlash in the gears. If the governor is ever replaced, check this clearance carefully as the lengths of the governor shafts may vary.

#### 5. LINKAGE - WOODWARD GOVERNOR TO FUEL WEDGE SHAFT

The governor linkage is illustrated in Fig. Q-3. Governor terminal shaft lever (3) is connected by means of collapsible link (4) to lever (6) which is clamped to shaft (5). This shaft in turn is linked to fuel wedge shaft (7) located inside of the cylinder block.

All of the levers are clamped and pinned to their respective shafts, so that they may be correctly reassembled if dismantled. Governor terminal lever (3) is mounted on the splined governor terminal shaft by means of a split splined bushing, which is pinned to the lever. If removed from the shaft it must be reassembled in the same position and shaft and lever should be marked prior to disassembly. Collapsible link (4) permits movement of the linkage to the stop position by the overspeed governor against the action of the Woodward governor. Under normal engine operation it acts as a fixed link, but when the overspeed governor trips, a spring inside the linkage collapses, shortening the link. Both ends are adjustable in the rod ends, and should be set to equalize the available governor shaft motion with the desired fuel wedge shaft motion.

#### 6. OVERSPEED GOVERNOR (With Woodward Governor Only)

The overspeed governor is built into the Woodward Governor drive. It is a safety device, stopping the engine in case of overspeeding by withdrawing the fuel wedges. Its operation is a definite indication that something is wrong, either with the regular governor or with the linkage, and the engine should not be run until the trouble has been located and corrected. UNDER NO CIRCUMSTANCES should operation of the engine be permitted with this device disconnected or made inoperative, as severe overspeeding of the engine may be very dangerous and may result in a complete wreck of the engine. The construction is illustrated in Fig. Q-3. Horseshoe shaped overspeed governor weight (12) is held to the governor drive shaft by a spring acting on a pin which goes through the drive shaft. The spring tension has been adjusted for a tripping speed approximately 7 to 10% above the normal operating speed by means of shims under the outer end of the spring. There should be no occasion for changing the shims, but the assembly can be dismantled if desired by pressing in on the spring end of the driving pin until the split washer on the weight end is free, allowing removal of this washer.

When the speed for which the spring is set is exceeded, the weight is thrown out by centrifugal force and engages the roller in the end of lever (14). This lever in turn raises spring loaded pin (11) and releases latch (13). Latch shaft (15) is also spring loaded, and when released it rotates, lifting rod (17). This rod projects into sleeve (19), which normally works up and down on the rod as the governor responds to variations in engine speed. Nuts (18) on rod (17) should be located so that there is approximately 1/32" to 1/16" clearance between the upper nut and the lower end of sleeve (19) when the fuel wedges are in full load position. When the overspeed governor trips and rod (17) is raised, nuts (18) engage and lift sleeve (19). This action rotates control shaft (5), pulling out the fuel wedges and stopping the engine. The stop may be reset by means of lever (16).



with and square to the bore in the opposite end of the casing. Drive gear (1) mounted on the end of the shaft meshes with the camshaft drive gear. Clearance between the governor bevel drive gears is determined by shims (2) under the governor and shims (8) in the ball bearing housing. These shims are adjusted to bring the gear teeth in line and to allow approximately .004" backlash in the gears. If the governor is ever replaced, check this clearance carefully as the lengths of the governor shafts may vary.

#### 5. LINKAGE - WOODWARD GOVERNOR TO FUEL WEDGE SHAFT

The governor linkage is illustrated in Fig. Q-3. Governor terminal shaft lever (3) is connected by means of collapsible link (4) to lever (6) which is clamped to shaft (5). This shaft in turn is linked to fuel wedge shaft (7) located inside of the cylinder block.

All of the levers are clamped and pinned to their respective shafts, so that they may be correctly reassembled if dismantled. Governor terminal lever (3) is mounted on the splined governor terminal shaft by means of a split splined bushing, which is pinned to the lever. If removed from the shaft it must be reassembled in the same position and shaft and lever should be marked prior to disassembly. Collapsible link (4) permits movement of the linkage to the stop position by the overspeed governor against the action of the Woodward governor. Under normal engine operation it acts as a fixed link, but when the overspeed governor trips, a spring inside the linkage collapses, shortening the link. Both ends are adjustable in the rod ends, and should be set to equalize the available governor shaft motion with the desired fuel wedge shaft motion.

#### 6. OVERSPEED GOVERNOR (With Woodward Governor Only)

The overspeed governor is built into the Woodward Governor drive. It is a safety device, stopping the engine in case of overspeeding by withdrawing the fuel wedges. Its operation is a definite indication that something is wrong, either with the regular governor or with the linkage, and the engine should not be run until the trouble has been located and corrected. UNDER NO CIRCUMSTANCES should operation of the engine be permitted with this device disconnected or made inoperative, as severe overspeeding of the engine may be very dangerous and may result in a complete wreck of the engine. The construction is illustrated in Fig. Q-3. Horseshoe shaped overspeed governor weight (12) is held to the governor drive shaft by a spring acting on a pin which goes through the drive shaft. The spring tension has been adjusted for a tripping speed approximately 7 to 10% above the normal operating speed by means of shims under the outer end of the spring. There should be no occasion for changing the shims, but the assembly can be dismantled if desired by pressing in on the spring end of the driving pin until the split washer on the weight end is free, allowing removal of this washer.

When the speed for which the spring is set is exceeded, the weight is thrown out by centrifugal force and engages the roller in the end of lever (14). This lever in turn raises spring loaded pin (11) and releases latch (13). Latch shaft (15) is also spring loaded, and when released it rotates, lifting rod (17). This rod projects into sleeve (19), which normally works up and down on the rod as the governor responds to variations in engine speed. Nuts (18) on rod (17) should be located so that there is approximately 1/32" to 1/16" clearance between the upper nut and the lower end of sleeve (19) when the fuel wedges are in full load position. When the overspeed governor trips and rod (17) is raised, nuts (18) engage and lift sleeve (19). This action rotates control shaft (5), pulling out the fuel wedges and stopping the engine. The stop may be reset by means of lever (16).



THE FOLLOWING INSTRUCTIONS APPLY IF YOUR PLANT  
IS TIED IN WITH OTHER PLANTS

Set the speed droop dial at about 50.

Start the engine and synchronize as above.

If the engine tries to take too great a share of the load changes, set the speed droop higher. If it does not take its share, set it lower.

Pick up load in the usual manner by adjusting the synchronizer knob.

It may be that if your system is not too large and you have one unit that is large enough to take care of any load changes that may occur, you can set its governor on zero speed droop so it will do all the regulating for the system, just as though it were a single plant. The best way to find out if you can do this is to try it, first making sure that the load limit is set so that the engine cannot be overloaded.

**STOPPING ENGINE:** Take the load off the engine by turning the synchronizer knob toward SLOW.

After the unit has been taken off the line, shut it down in the usual way.

THE FOLLOWING INSTRUCTIONS APPLY IF YOUR ENGINE  
IS NOT DRIVING AN A.C. GENERATOR

If your engine is driving a D.C. generator, pump, or anything but an alternating current generator, set the speed droop at zero on all engines. In direct current service, it is occasionally desirable to run with a little speed droop to aid in load division, particularly in cases where generator compounding is not identical.

TAKING CARE OF YOUR GOVERNOR

It will not take much care to keep your Woodward Governor running properly for many years.

**OIL:** Keep the governor oil level high enough so it can be seen in the gage glass. Your regular engine oil will be all right although SAE 20 to 30 is usually best. The oil should be acid-free and should not sludge or retain air. **IT MUST BE CLEAN AND NEW.** Wash your pail or oil can thoroughly with gasoline before you use it for governor oil.

Should any part become worn or damaged, you can order a new one, giving its part number as shown on the drawings and the serial number of the governor.

**ALWAYS GIVE THE SERIAL NUMBER OF YOUR GOVERNOR WHEN WRITING OR ORDERING PARTS.**

INSTRUCTIONS TO ENGINE ERECTORS

You will not find it difficult to install and adjust a Woodward type UG-8 governor. If the governor was fitted on the engine at your factory, you will only have two simple things to do. If they are not done, the governor will not work properly, and your engine will not perform as well as other engines whose governors are correctly adjusted.

1. PUT IN OIL

(a) Fill the governor with oil through the filler cup in the governor cover. The level must be brought up to a point where the oil shows in the gage glass on the front of the governor. This level should be maintained in service.

**USE CLEAN, NEW ENGINE OIL.** The pail or can used to carry oil to the governor should be thoroughly washed with gasoline before it is used.

(b) It is a good idea to roll the engine over slowly a few revolutions to fill the governor cylinder with oil. This is not necessary, but it will make the first start of the engine much smoother.



## 2. ADJUST THE COMPENSATION

The compensation adjustments made at your factory may not be satisfactory when the engine is installed in the field. You should go through the procedure indicated here, even though the governor appears to work all right. The fact that a governor does not hunt does not necessarily mean that it is correctly adjusted.

- (a) Loosen the nut holding the compensation adjusting pointer 70-6 and set the pointer at its extreme downward position.
- (b) Remove the compensating screw plug 54-7 and open compensating screw 36-11 two or three turns.
- (c) Start the engine and let it hunt for thirty seconds or so.
- (d) Gradually close the needle valve until hunting stops, or until it is only about 1/8 turn open.
- (e) If this does not stop the hunting, open the needle valve to about one turn and raise the compensation adjusting pointer about two graduations.
- (f) Close the needle valve gradually again as under (d).
- (g) Repeat until hunting stops.
- (h) It is desirable to have as little compensation as possible. Closing the needle valve farther than necessary will make the governor slow to return to normal speed after a load change. Excessive dashpot plunger travel caused by adjustment of the compensation adjusting pointer too far toward maximum position will cause excessive speed change upon load change.

## METHOD OF OPERATION

### SCHEMATIC OPERATION

Movements of the operating parts of the governor are actually proportional to the amount of speed change, but have been greatly exaggerated in the drawings to make them more visible.

Assume, for the purpose of explanation, that the prime mover is rotating at normal speed as shown on the speed indicator and carrying approximately half load as shown by the black hand. Assume, also, that the governor adjustments are all properly set and that speed droop is zero.

### LOAD REDUCTION

Cut #1. The flyballs are in their normal position for the respective speed and no speed droop. The load limit is set at about 9/10 load, as shown by the red hand. The pilot valve is central. The power piston is stationary. The larger or actuating compensating plunger is approximately central. The small or receiving compensating plunger is central.

Cut #2 A certain amount of load is thrown off the unit. The speed instantly starts to increase. As the speed increases, the flyballs move out, the speeder rod is forced up against the downward thrust of the speeder spring, pivot points "A" and "B" are raised, the pilot valve plunger is lifted from its central position, and pressure oil is admitted from "P" through the center holes in the pilot valve bushing into port "X" and on into the power cylinder where it starts moving the power piston down, which rotates the terminal shaft to reduce the flow of energy medium to the Prime mover. Oil laying on the lower side of the power piston is forced out through port "Y", through the lower hole in the pilot valve bushing and into the sump "S".

Cut #3. As the power piston moves down, pivots "D", "E" and "F" are pulled down and "G" is raised. The larger or actuating compensating plunger is, therefore, raised. Since the compensating dashpot is filled with oil, the upward movement of the compensating actuating plunger pulls the smaller or receiving compensating plunger downward against the upward force of the double acting compression compensating spring, which attempts to keep the receiving plunger central at all times. The downward movement of the compensating receiving plunger pulls pivot "C" downward and as pivot "A" is temporarily stationary due to the fact that the flyballs are still in their outward position, it acts as a fulcrum, causing the downward movement of pivot "B", and consequently the pilot valve plunger. These various parts do not make a single, definite and complete move but make short moves in sequence and the action is continued until the pilot valve plunger is lowered to its central position, thus stopping the flow of pressure oil from "P" to port "X" and thus stopping the motion of the power piston.



If the movements of the various parts have been properly proportioned and inter-related, the pilot valve plunger will be centered and the movement of the power piston will be stopped at a position corresponding to a flow of energy medium just sufficient to accommodate the reduced load on the unit. All that is necessary now is to hold the power piston stationary until the speed returns to normal or until a subsequent speed change occurs.

The upward movement of the actuating compensating plunger created a vacuum in the compensating dashpot case, which caused the receiving plunger to be drawn downward. At the same time, oil from the sump "P" began to flow through the compensating needle valve into the case to break up the vacuum and allow the compensating spring to return the receiving plunger to its central position. The needle valve is small and consequently had little effect while the actuating plunger was in motion. Now, however, the movement of the actuating plunger has stopped and, therefore, the flow through the needle valve will allow the compensating spring to bring the receiving plunger back to normal at any predetermined rate according to the setting of the needle valve. If the needle valve has been properly set, the receiving plunger will return to its central position in exact unison with the return of the prime mover speed to normal and consequently the return of the flyballs to their normal central position. Such being the case, pivot "C" will move upward in exact ratio to the downward movement of pivot "A" caused by the return of the flyballs to center. Pivot "E" will, therefore, remain stationary, the pilot valve plunger will not be disturbed, and the power piston will remain stationary.

Cut #4. The cycle has been completed, the speed is normal, the load is as shown by the black hand, the flyballs are central, the receiving compensating plunger is central, and the power piston is stationary. The only permanent changes that have resulted are the position of the black hand, which shows the new loading of the unit; the position of the power piston; and the position of the compensating actuating plunger.

#### LOAD INCREASE

The action when load is added to the unit is just the reverse. The speed starts to drop, the flyballs move in, pivots "A" and "B" are lowered, the pilot valve plunger is lowered, pressure oil is admitted from "P" to "Y" and the power piston moves up to rotate the terminal shaft and increase the flow of energy medium. As the power piston moves up, pivots "D", "E" and "F" are raised and "G" is lowered. The compensating actuating plunger is forced downward, the compensating receiving plunger is forced upward, raising pivot "C" and lowering pivot "B" until the pilot valve plunger centers, stops the flow of pressure oil into port "Y" and stops the movement of the power piston at the exact position corresponding to the increased load on the unit. As the energy medium flow is corrected, the speed of the unit returns to normal. In unison with the return of the speed to normal and consequently the return of the flyballs to their central position, the compensating receiving plunger, due to the flow of oil out through the compensating needle valve and the centering action of the compensating spring, returns to its central position. The pilot valve plunger is not disturbed and the power piston remains stationary awaiting another change in speed resulting from a change in load.

#### THE LOAD LIMIT

The purpose of the load limit is to prevent the unit from taking on more load than that for which the red hand is set by mechanically preventing the pilot valve plunger from rising above center when a loading corresponding to the setting of the red hand has been reached. It also provides a means of shutting the unit down by merely turning the red hand to zero.

Action: Referring to the cuts, as the power piston moves upward to increase the flow of energy medium, pivot "D" is forced upward, lifting the left end of the load limit lever. Just as the top of the load limit lever contacts the load limit cam, the shutdown lever contacts the top of the slot in the pilot valve plunger stem. As the power piston continues to rise, the load limit lever is rotated clockwise, pushing down on the shutdown rod and on the left end of the shutdown lever, and thus lifting the pilot valve plunger back to center. The flow of high pressure oil from "P" through port "Y" to the lower side of the power piston is cut off and the power piston is brought to a stop so that the load on the engine is exactly that for which the red hand was set. Any attempt of the flyballs to increase the flow of energy



medium further does not affect the pilot valve as it is held from moving below center by the shutdown lever. The spring coupling absorbs the downward movement of the speeder rod.

To reduce the load limit setting or to shut the unit down completely, turn the red hand counter-clockwise. The load limit cam will force the load limit lever to revolve clockwise about "D", forcing the shutdown lever to lift the pilot valve and allow high pressure oil from "P" to enter port "X". The power piston moves down, as does pivot "D". As pivot "D" moves down, the load limit lever rotates counter-clockwise about its contact point with the cam, since it is held upward against the cam by the power piston rod on one end and by the spring coupling through the shutdown lever on the other end. Downward movement of the power piston is stopped when the load limit lever reaches a position where the pilot valve plunger can regain its normal central position.

#### SPEED DROOP

The purpose of speed droop is to cause all units operating in parallel to take their proportionate share of the total load.

Action: As shown in the cuts, the speed droop fulcrum is exactly over pivot "I" and consequently does not produce a drooping of the unit speed as the unit takes on load. In other words, the speed of the unit will remain the same regardless of the amount of load on the unit (within the capacity of the unit). But, revolve the speed droop knob clockwise and the speed droop fulcrum will be moved along the speed droop lever and consequently away from exact center. The farther away from exact center it is moved, the greater will be the droop in the speed.

With the speed droop fulcrum off center, assume that the power piston moves to increase energy medium flow. The terminal shaft will be revolved counter-clockwise. Pivot "H" will be lowered and, as the speed droop fulcrum is not directly over pivot "I", pivot "I" will be raised, thus relieving some of the compression on the speeder spring. The flyballs will, therefore, recenter at a lower speed than before and the pilot valve will be centered and the power piston stopped before it reaches a position corresponding to the original speed. In other words, the speed of the unit will not be returned to the speed at which it was operating but to a slightly lower speed of an amount corresponding to the distance the speed droop fulcrum is off center.

If the power piston moves in the direction to decrease energy medium flow, the speed will raise an amount corresponding to the distance the speed droop fulcrum is off center.

#### THE SYNCHRONIZER

The purpose of the synchronizer or speed adjusting mechanism is to permit varying the unit speed for synchronizing when the unit is being paralleled with other units. If the unit is operating in parallel on a system many times the capacity of the individual unit, an adjustment of the speed setting will result in a change of the system speed, but the change in speed may be so infinitesimal as to be unreadable on ordinary switchboard instruments. Practically, therefore, a change in the synchronizer setting merely changes the loading of the unit due to the small amount of influence the capacity of the unit has on the total capacity of the system.

Action: Revolve the synchronizer knob clockwise. The gearing is such that the speeder gear revolves clockwise, thus screwing down on the speeder screw against the speeder spring. The increased loading on the speeder spring causes the flyballs to move in. The pilot valve is pushed down, the power piston moves up to increase the flow of energy medium and thus the speed of the unit. The unit will increase in speed until the flyballs return to their normal central position and stop the action of the pilot valve. This speed will be the normal speed of the unit until the synchronizer is again reset.

Revolving the synchronizer knob counter-clockwise will cause a reversal of operation and the unit speed will be lowered.



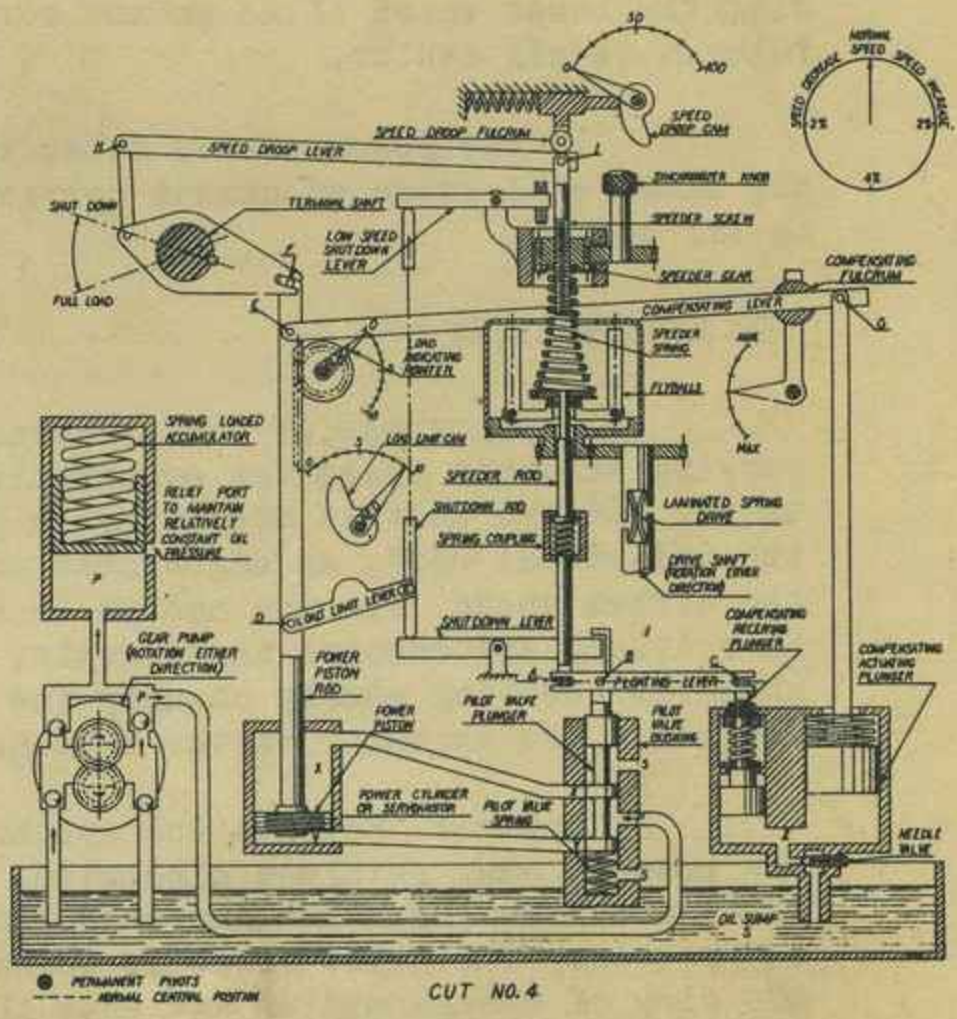
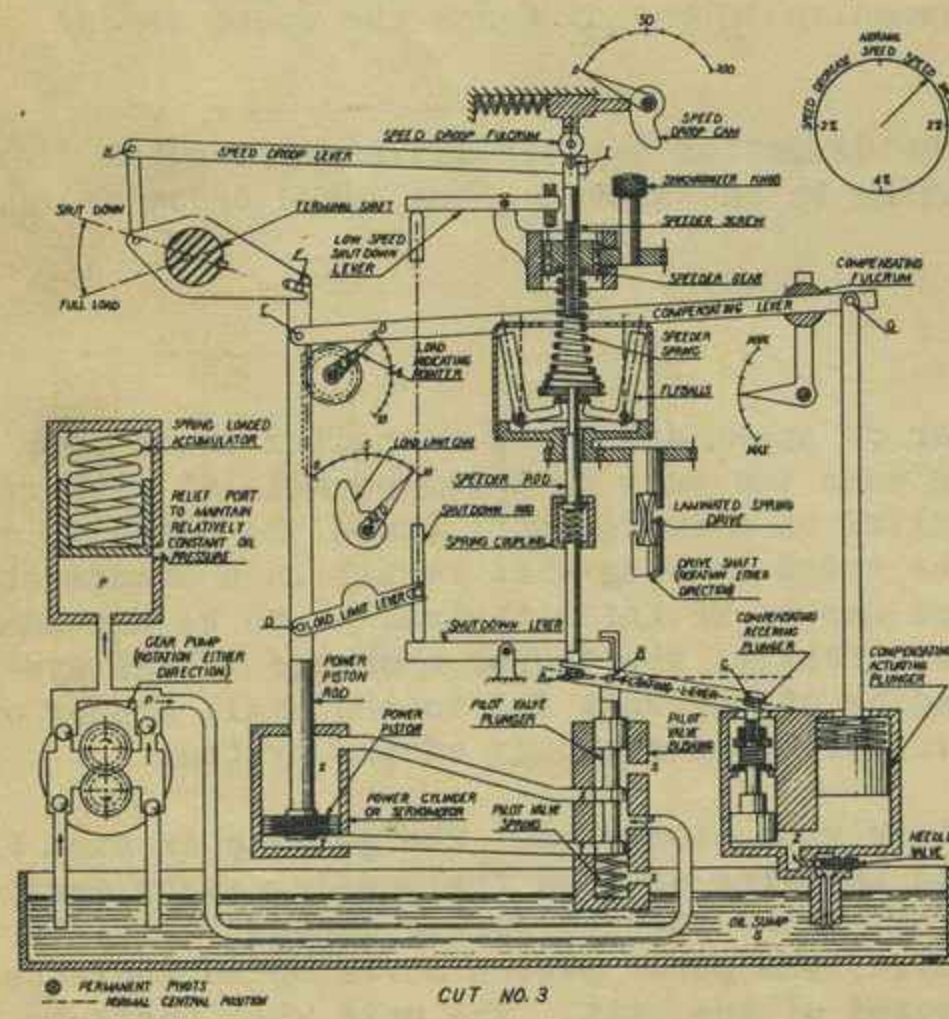
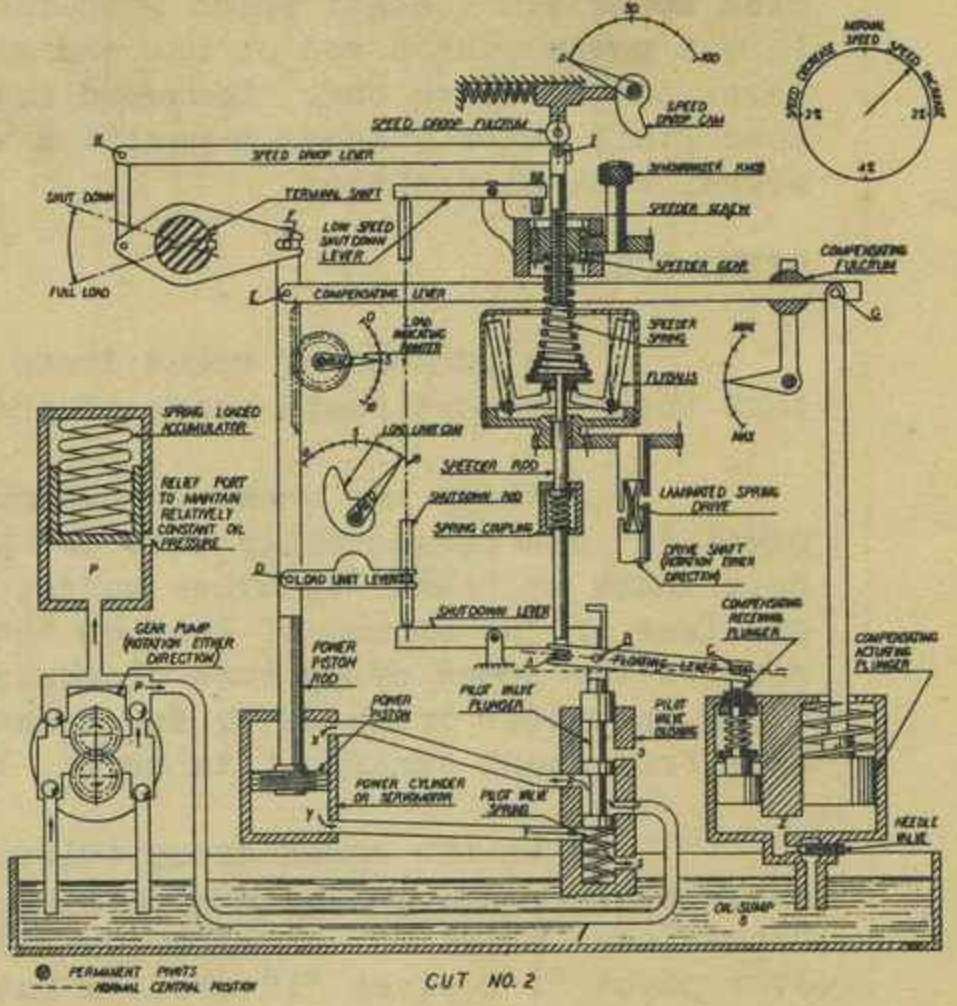
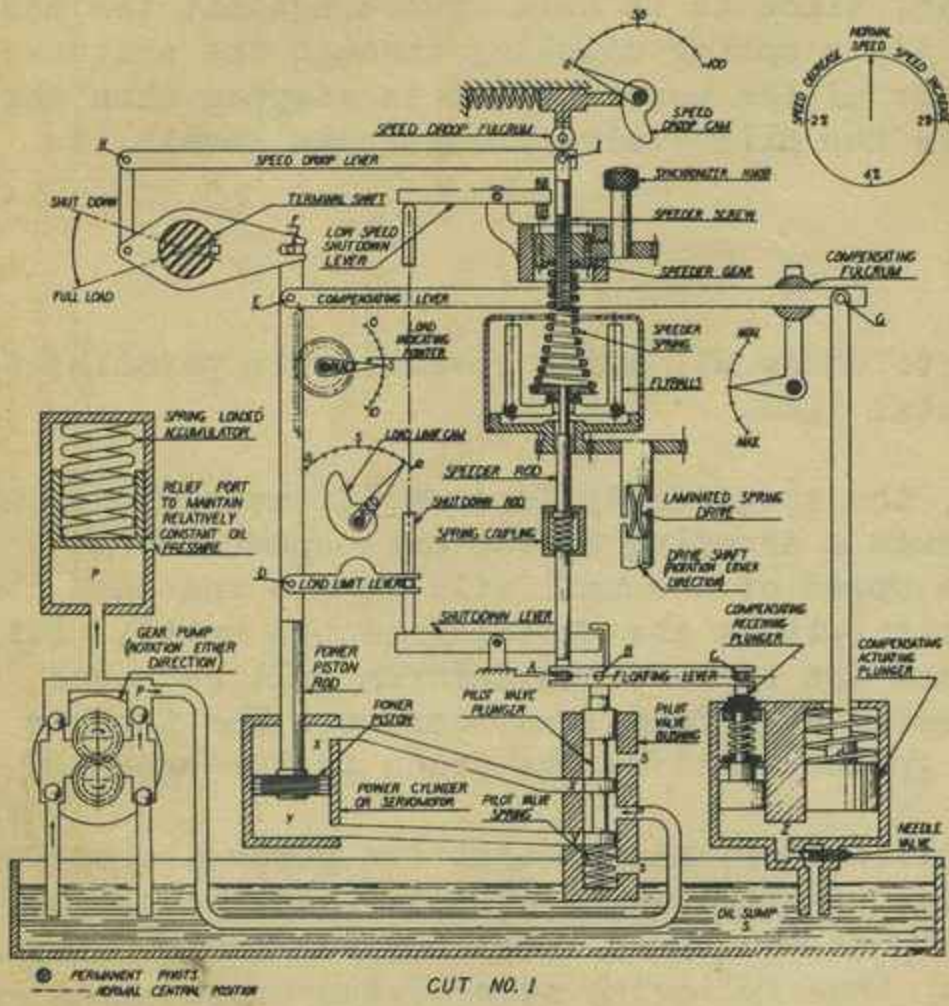







SECTION A-A

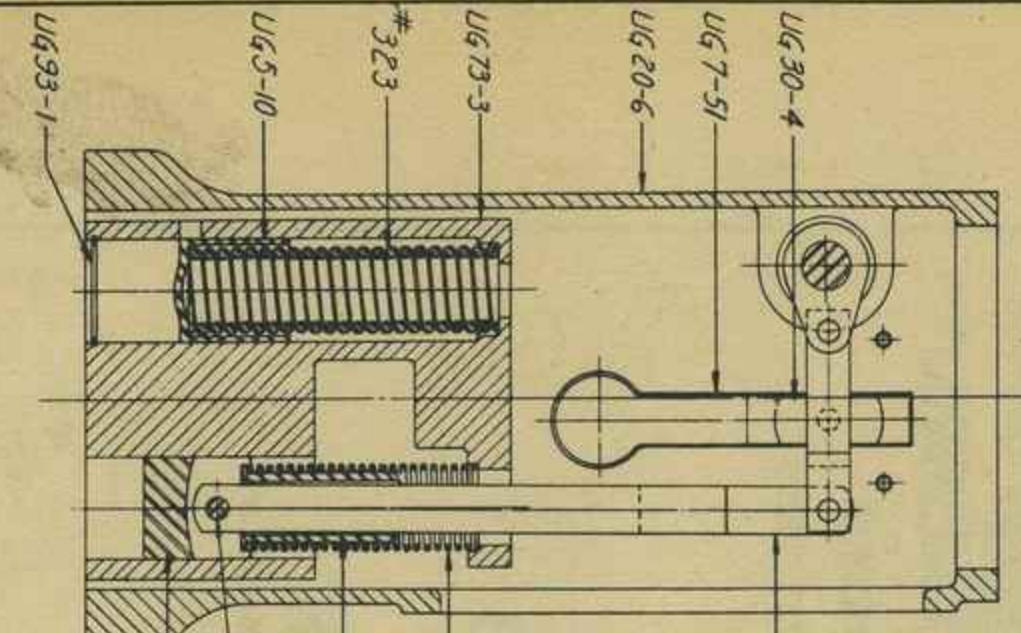

SECTION B-B

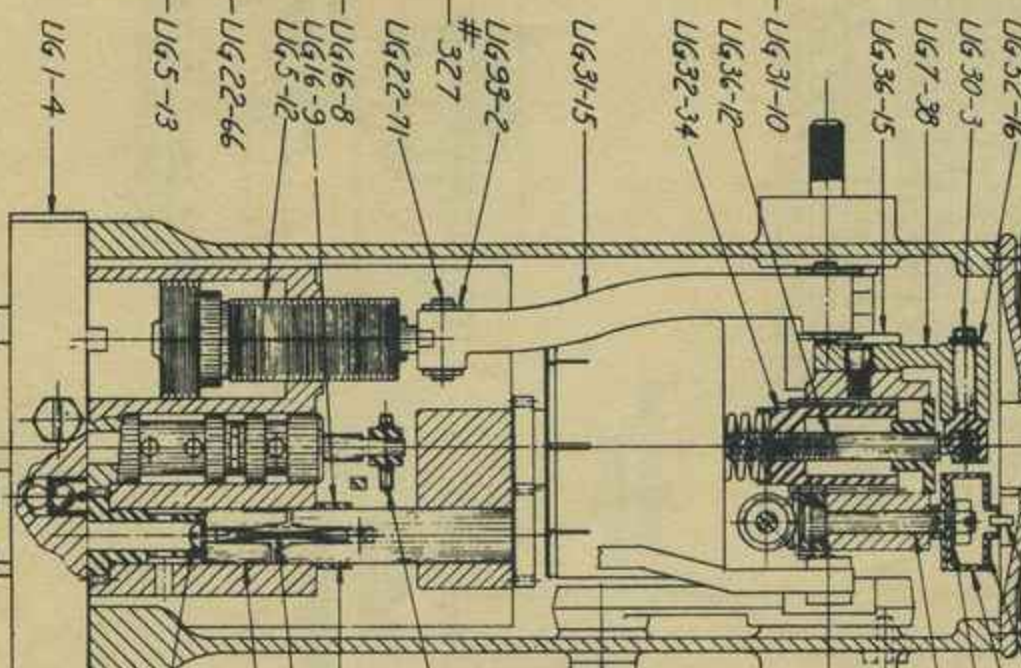

SECTION C-C

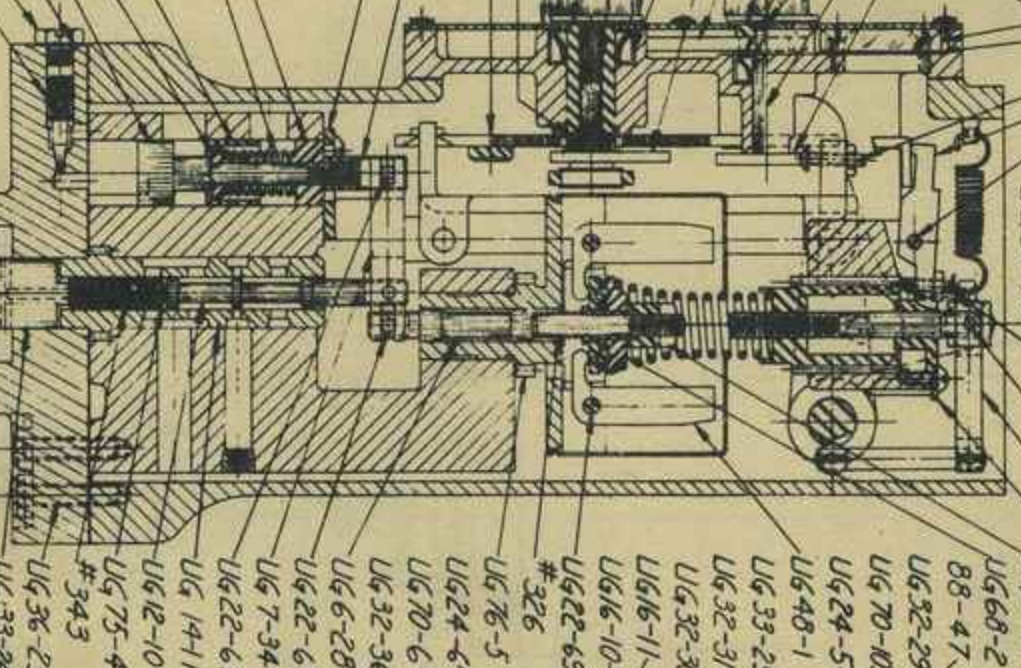

SECTION D-D

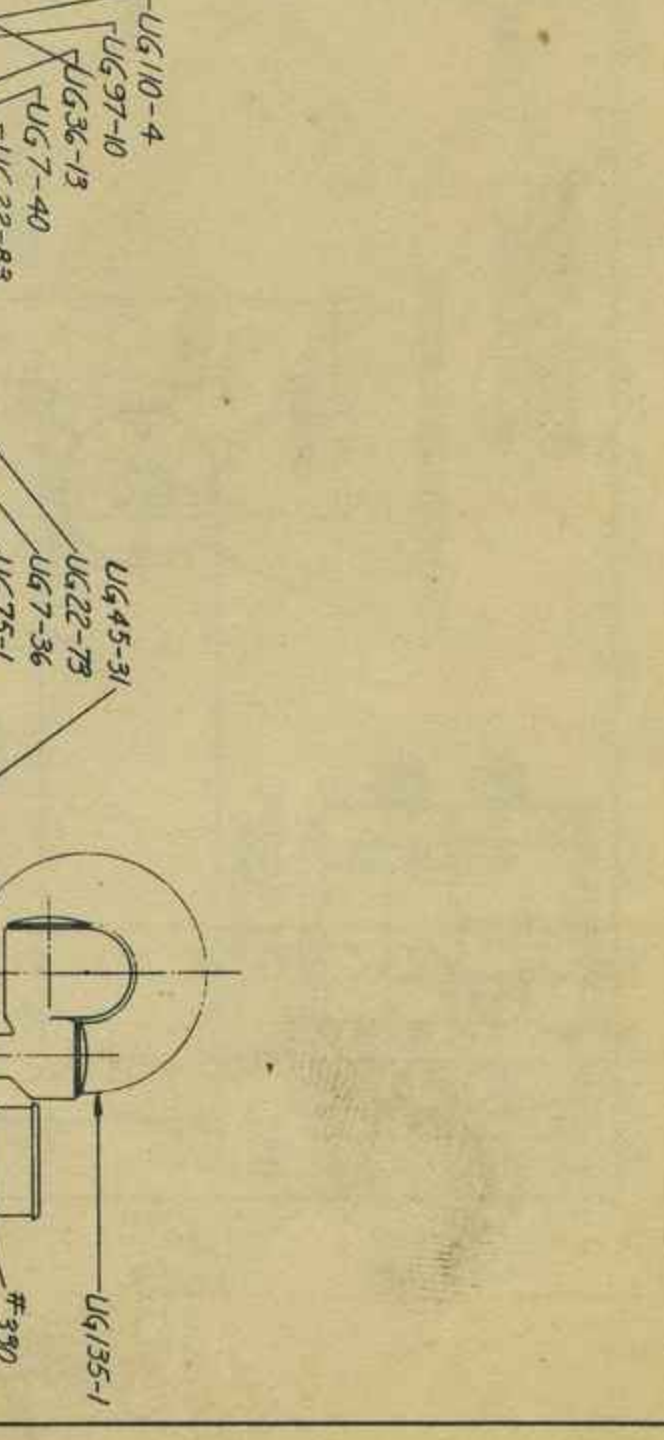
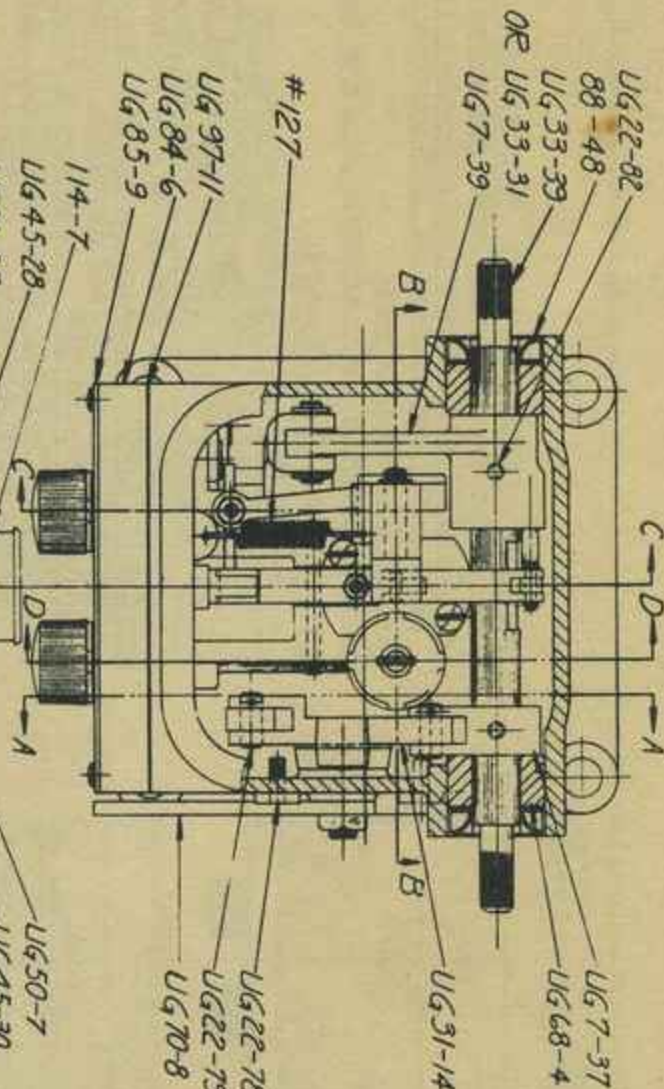
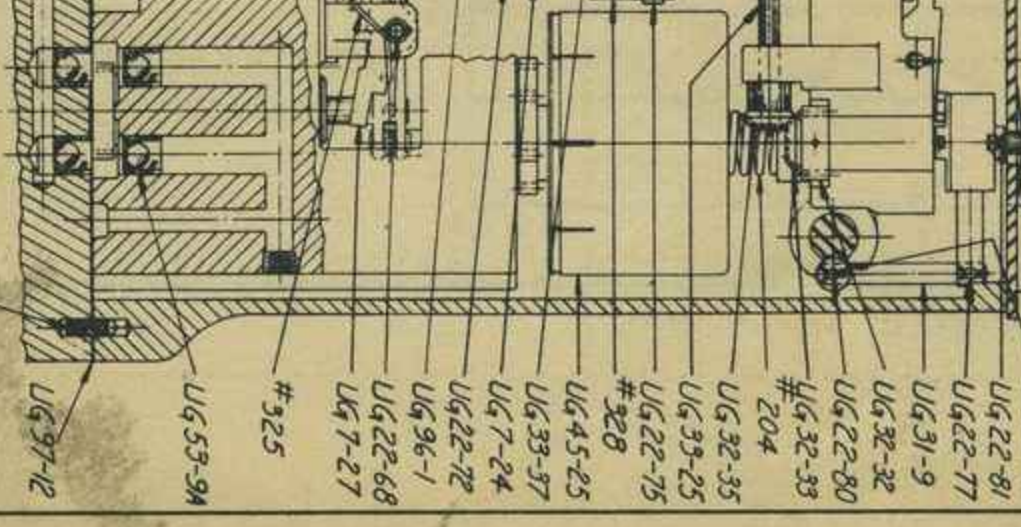

WOODWARD  
GOVERNOR COMPANY  
MADE IN U.S.A.

UG 8 GOVERNOR  
ASSEMBLY

V-141

- UG 22-02
- 88-48
- UG 33-39
- OR UG 33-31
- UG 7-39
- UG 97-11
- UG 84-6
- UG 85-9
- #127
- UG 45-28
- UG 36-27
- UG 52-16
- UG 30-3
- UG 7-38
- UG 36-15
- UG 31-10
- UG 36-12
- UG 32-34
- UG 31-15
- UG 93-2
- #327
- UG 22-71
- UG 16-8
- UG 16-9
- UG 5-12
- UG 22-66
- UG 5-13
- UG 1-4
- UG 7-37
- UG 68-4
- UG 31-14
- UG 22-78
- UG 22-79
- UG 70-8
- UG 50-7
- UG 45-30
- UG 20-7
- #329
- UG 33-27
- UG 10-5
- UG 33-30
- UG 22-76
- 88-35
- UG 21-6
- #328
- UG 10-6
- 88-46
- UG 70-11
- UG 33-26
- UG 32-37
- UG 70-7
- UG 52-15
- UG 61-2
- UG 22-70
- UG 34-6
- UG 45-21
- UG 32-28
- UG 98-1
- UG 32-27
- UG 21-10
- #338
- UG 22-65
- UG 14-18
- UG 21-11
- UG 5-10
- UG 52-11
- UG 54-7
- UG 36-11
- #47503
- 93-3
- UG 110-4
- UG 97-10
- UG 36-13
- UG 7-40
- UG 22-83
- UG 36-14
- UG 45-31
- UG 22-73
- UG 7-36
- UG 75-1
- UG 34-11
- UG 68-2
- 88-47
- UG 32-29
- UG 70-10
- UG 24-5
- UG 48-1
- UG 33-29
- UG 32-31
- UG 32-30
- UG 16-11
- UG 16-10
- UG 22-69
- #326
- UG 76-5
- UG 24-6
- UG 70-6
- UG 32-36
- UG 6-28
- UG 22-67
- UG 7-34
- UG 22-67
- UG 14-11
- UG 12-10
- UG 75-4
- #343
- UG 36-25
- UG 33-24
- 88-44
- UG 55-11
- UG 36-26
- UG 135-1
- #390
- UG 32-17
- UG 22-81
- UG 22-77
- UG 31-9
- UG 32-32
- UG 22-80
- UG 32-33
- #204
- UG 32-35
- UG 33-25
- UG 22-75
- #328
- UG 45-25
- UG 33-37
- UG 7-24
- UG 22-72
- UG 96-1
- UG 22-68
- UG 7-27
- #325
- UG 53-94
- UG 97-12
- 22-103



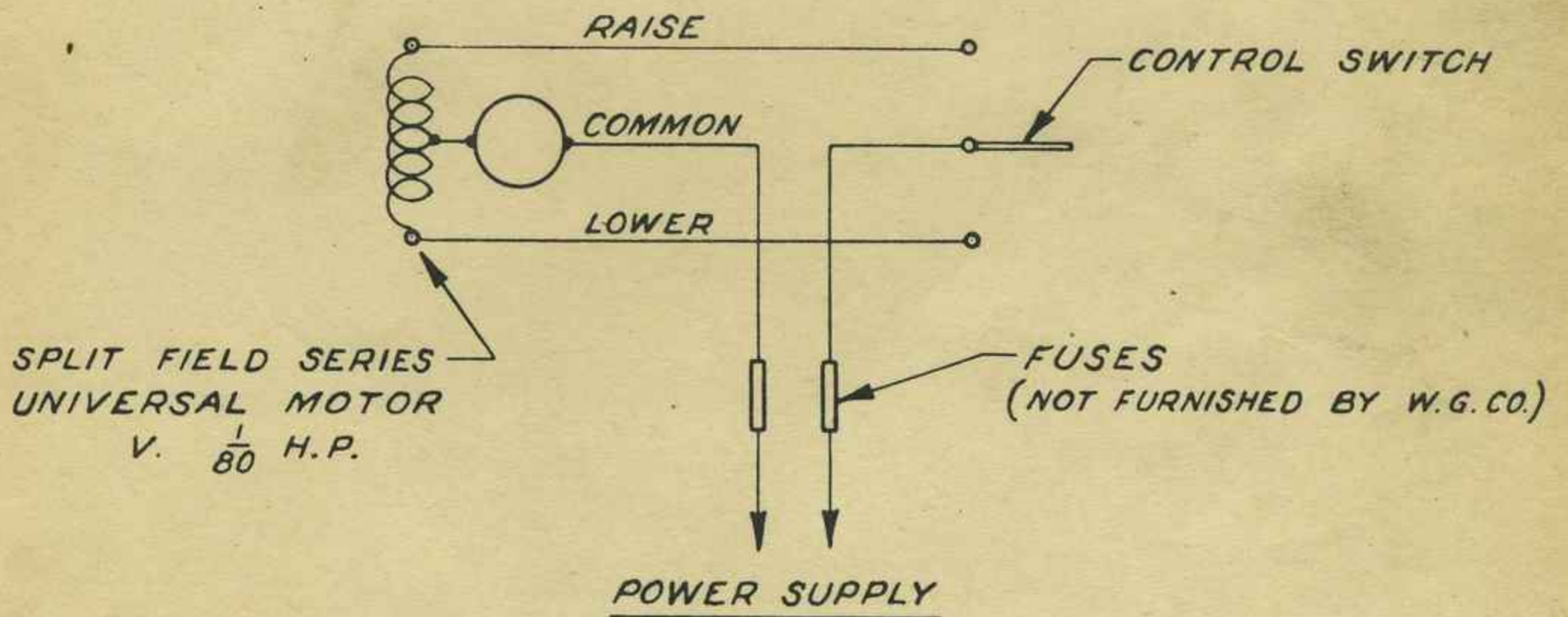
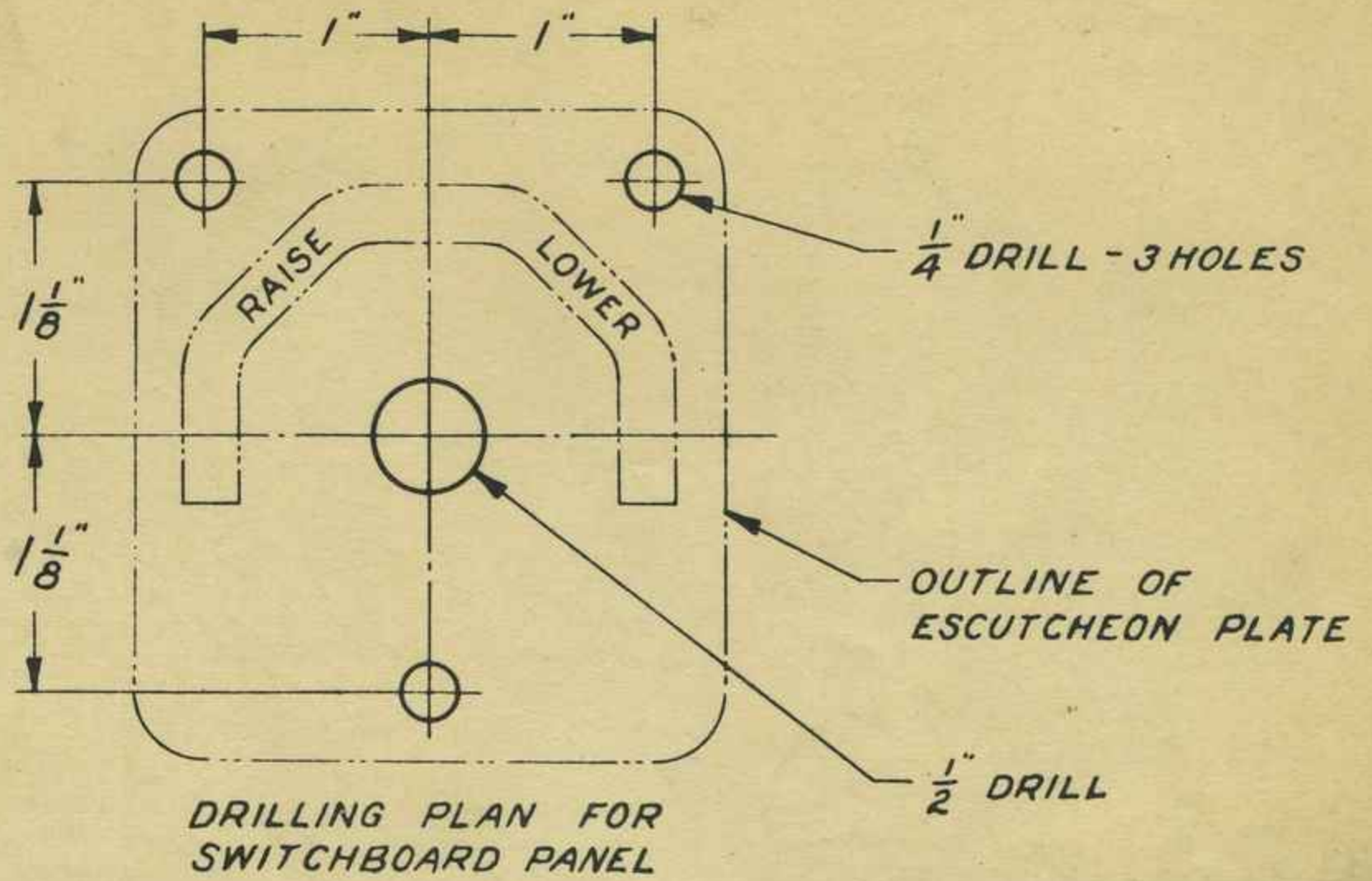

<p>NAME <i>WIRING &amp; MOUNTING DIAGRAM</i></p> <p>SPECIFICATIONS  <i>SYNCHRONIZING MOTOR</i>  <i>GATE LIMIT MOTOR</i></p> <p>FOR <i>G.E. CONTROL SWITCH #16SBIAAI</i></p>	<p>WOODWARD GOVERNOR CO.          ROCKFORD, ILLINOIS</p> <p>DATE <i>12-1-37</i>          SCALE <i>12"=1'-0"</i></p> <p>DRG. No.  <i>WD 115</i></p>
---	--



LUBRICATING OIL SYSTEM

1. The lubricating oil system consists of the oil sump (either in a separate sump tank or in the engine base), the lubricating oil pump, the lubricating oil strainer and cooler, and the necessary piping and manifold to carry the oil through the engine and to the bearings.

In addition to the lubricating oil system as outlined above, there is also the Madison-Kipp sight feed lubricator, which supplies a measured quantity of oil to each piston and cylinder liner.

The normal flow of oil through the system is from the oil sump to the pressure pump, then through the lubricating oil strainer and cooler to the main bearing manifold in the base, from which connections lead to each main bearing. Drilled holes in the crankshaft carry the oil from the main bearing journals to the crankpin bearings, from which it feeds up to the piston pin bearings through the rifle drilled connecting rods. The oil drains down into the bottom of the engine base, where, in "wet base" engines it collects in the base sump, to be sucked up again by the pressure pump. In "dry base" engines with sump pump it is scavenged from the base by the sump pump and delivered to the day tank, to which the suction of the pressure pump is connected. In "dry base" engines without sump pump the oil drains by gravity from the drain trough in the bottom of the base to the sump tank.

2. LUBRICATING OIL SUMP - WET BASE ENGINES

On the sump type, or so called "wet base" engines, the lubricating oil sump pan is bolted to the bottom of the engine base. The sump is hopper shaped and carries the entire supply of oil for the engine. The oil drains into the sump through holes in the bottom of the base. Screens covering these holes are removable from inside of the base and should be thoroughly washed out when the oil is changed.

A bayonet gage projecting down into the sump from the side of the base indicates the oil level. It should NEVER BE ALLOWED TO DROP BELOW THE "LOW" mark on the gage, and should preferably be kept up near the "FULL" mark. A drain plug is provided at the bottom of the sump pan, and unless it is readily accessible after the installation is completed it should be piped to a convenient location. Do not use a pipe smaller than the connection, and keep it short.

3. LUBRICATING OIL DAY TANK (Engines with Sump Pump)

The lubricating oil is discharged by the sump pump to the cylindrical lubricating oil day tank of about 20 gallons capacity. The tank should be located above the level of the engine and reasonably close to it. A casting riveted to the top of the tank supports a screen and provides two openings, one for the discharge pipe from the sump pump and a filler opening for adding new oil to the system. A gage glass near the top indicates the depth of oil in the tank. It should be kept near the center of the glass and SHOULD NEVER BE ALLOWED TO DROP BELOW THE GLASS. A connection is provided for the pressure pump suction about eight inches above the bottom of the tank. There is also an opening at the bottom, which should be provided with a valve or cock to permit draining off the sludge.

4. LUBRICATING OIL SUMP (Dry Base Engines Without Sump Pump)

A separate cylindrical sump tank of about 20 gallons capacity is furnished for dry base engines without sump pumps. The tank must be located below the engine level so that the oil can drain to it by gravity. A casting riveted to the top of the tank provides an opening for the oil drain from the engine and also a filler opening through which new oil can be added to the system. All oil entering the tank passes through a screen supported by the top casting. The oil level in the tank may be determined through the filler opening by means of a sounding rod. It should be kept up to within about four inches of the top of the tank and should NEVER BE ALLOWED TO DROP TO MORE THAN EIGHT INCHES BELOW THE TOP.

It is good practice to thoroughly wash out the tank when changing oil. The suction pipe from the pressure pump extends nearly to the bottom of the tank and carries a foot valve on the lower end to keep the pump primed.

5. LUBRICATING OIL PRESSURE PUMP

The lubricating oil pump, illustrated in Fig. T-1, is of the internal gear type. It is mounted on one of the centerframe doors, on the control side of the engine, and is driven from a gear on the camshaft. Referring to Fig. T-1, the end clearance between pump rotor (3) and the housing should be from .001" to .003", and is determined by the thickness of paper gaskets (2) under cover (1). If the clearance is



## Section T

too great the pump efficiency will be reduced and if insufficient the rotor will bind. If the gaskets are replaced, measure the thickness with a micrometer and replace with exactly the same thickness.

Pump shaft (9) rotates in bronze bushings (8) which are pressed into the housing. If replaced, ream to .7500" to .7505" after pressing in. Drive gear (10) is keyed to the shaft and locked in place by a set-screw, which must be securely wired. The pump housing is positioned and doweled on the center-frame to allow .004" to .006" gear backlash. The gasket under the housing is 1/32" thick, which must be maintained or the backlash will be altered.

### 6. LUBRICATING OIL PRESSURE REGULATING VALVE

The spring loaded lubricating oil regulating valve (7) is built into the pump housing, as illustrated in Fig. T-1. The entire assembly is contained in cage (4), which is screwed into the housing against a copper gasket. It is sealed by cap (6) screwed onto the projecting end of the cage against a second copper gasket. The valve is adjustable by means of spring retaining plug (5), which may be screwed in or out of the cage. The adjustment is locked by a wire through the cage and plug as shown, and should be maintained at 40 to 50 lbs. per square inch.

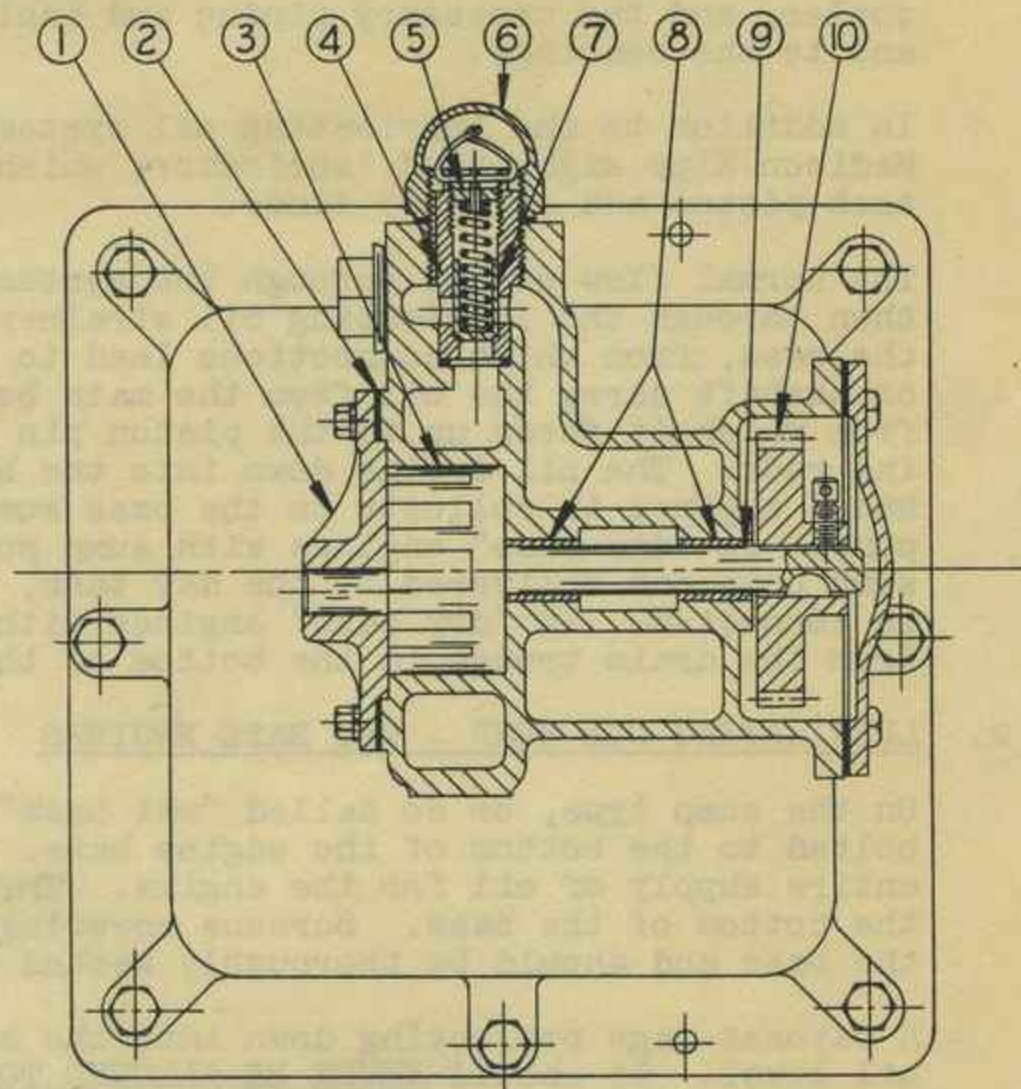

FIG. T-1

Note that low lubricating oil pressure may not necessarily be due to relief valve adjustment. It may result from one or more of the following causes. They should be investigated before attempting to correct the pressure by adjusting relief valve at the pressure pump.

- (a) Low lubricating oil level in filter and day tank unit.
- (b) Restriction in suction pipe to either of the lubricating oil pumps.
- (c) Broken pressure pipes or fittings.
- (d) Crankshaft bearing failure.
- (e) Worn pump gears.
- (f) Viscosity of oil too low, excessive temperature of oil, or thinning out with fuel oil.

### 7. SUMP PUMP

When a sump pump is used it is identical with the pressure pump as described in Paragraph 4, except that the relief valve is not used. A blind plug fills the hole in the pump housing. The sump pump runs at a somewhat higher speed than the pressure pump.

### 8. LUBRICATING OIL COOLER

The lubricating oil cooler is mounted on the manifold side of the engine, and a pipe crossing through the engine below one of the main bearing saddles carries the oil from the pump to the cooler. The discharge from the cooler is piped back into the engine base, to the main bearing manifold.

The construction of the Ross type oil cooler is shown on Fig. T-2. The shell of the cooler is a completely closed circuit effected by brazing the tube sheets on each end to the seamless copper shell, and then mechanically rolling the tubes securely into the tube sheets at both ends. The bonnets are bolted to the shell flanges, with molded asbestos gaskets between, and can be removed for inspection and cleaning of the inside of tubes. The flow of the oil is guided by bronze baffles inside the shell to produce the most efficient heat transfer.



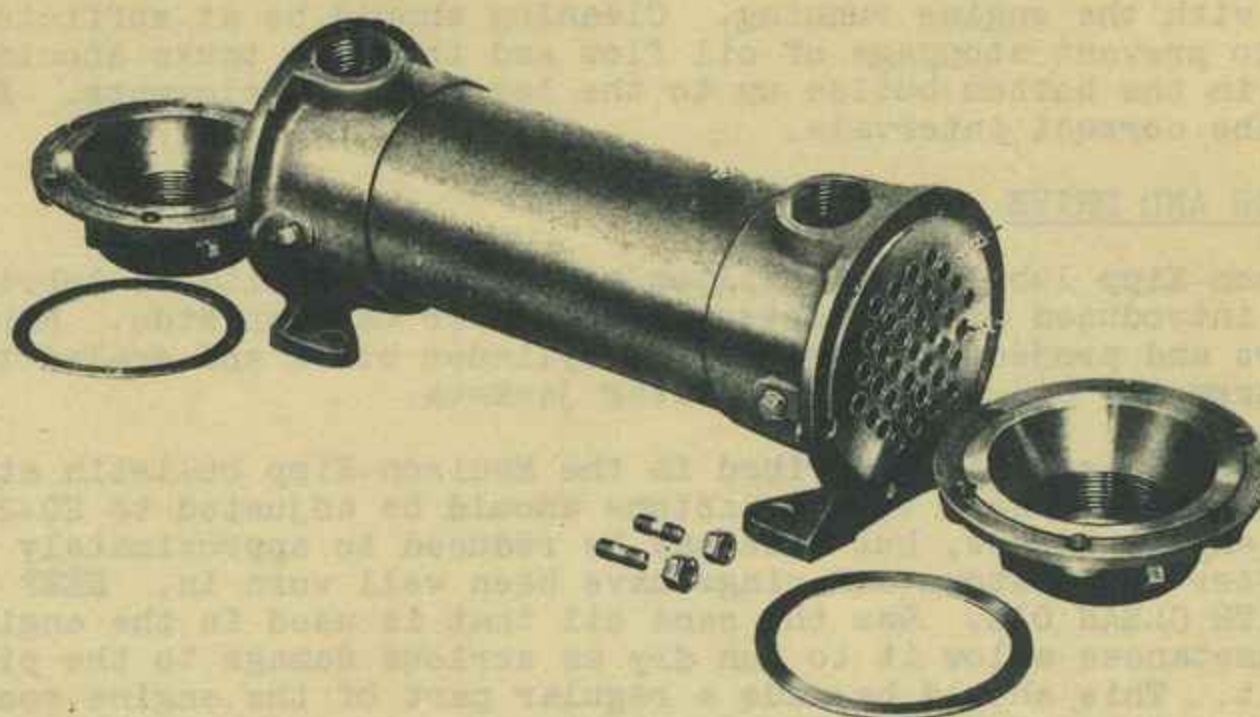

FIG. T-2

Zinc electrode plugs are provided in the bonnets to prevent electrolysis. They should be examined thirty days after installation and every thirty days thereafter. Any appreciable erosion within this period indicates electrolytic action, and if present a careful inspection should be made to determine if it is due to short circuits or external grounded electric currents. Any such conditions should be corrected at once, but if no external currents are found it is evident that the erosion is due to local electrolysis, and the zincs should be replaced frequently to protect the equipment.

The cooler should be cleaned periodically. Remove the cooler from the engine, take off the bonnets and clean the inside of the tubes. Fill the jacket with suitable cleaning solution, but avoid any fluids which are corrosive to bronze or copper. Drain and blow out with compressed air carefully.

The drain plugs at the bottom of both bonnets should be removed and all water in the cooler drained out whenever the engine is allowed to stand in freezing weather.

#### 9. LUBRICATING OIL STRAINER

The lubricating oil strainer is connected in a by-pass line, taken from the main flow at the cooler inlet and discharging the filtered oil to the governor and fuel pump bearings.

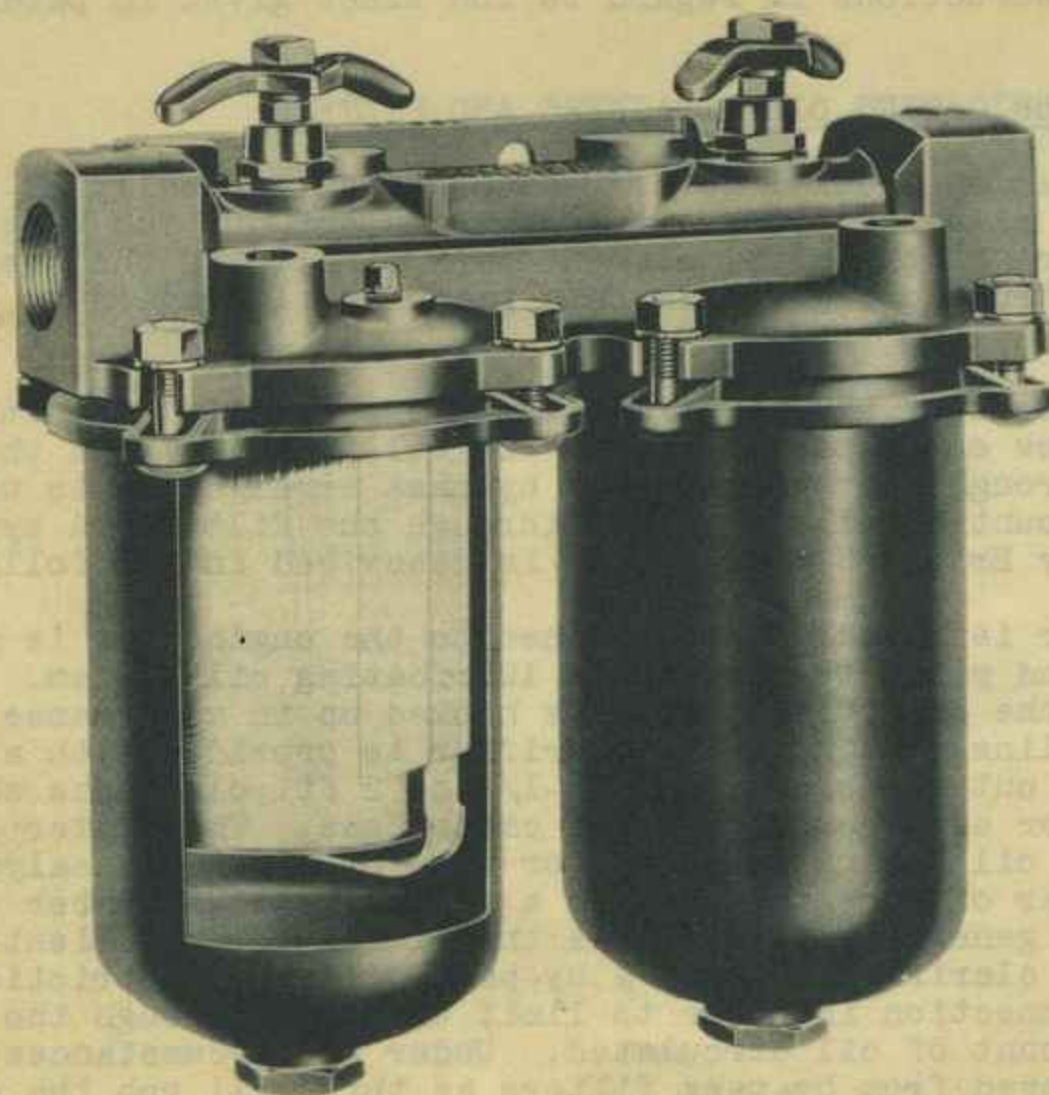

FIG. T-3

The strainer is of the metal element type as shown on Fig. T-3. The elements are made up of flat metal ribbon wound around a central spool, adjacent layers being slightly separated from each other by raised ridges running across the ribbon. The successive layers of the ribbon are spaced .003" apart and it is these spaces that form the filtering medium. The oil flows from the outside toward the center and leaves the dirt on the outside of the spool. The strainer may be cleaned by turning the cleaning handles on top, which rotate knives bearing on the edges of the windings, scraping off the dirt and allowing it to settle to the bottom of the sump tanks. The strainer should preferably be cleaned when the engine is not



## Section T

running so that the dirt may settle to the bottom, although there is no objection to cleaning with the engine running. Cleaning should be at sufficiently frequent intervals to prevent stoppage of oil flow and the sump tanks should be drained before the dirt in the bottom builds up to the level of the elements. Experience will determine the correct intervals.

### 10. LUBRICATOR AND DRIVE

The Madison-Kipp lubricator supplies a measured quantity of lubricating oil to the pistons, introduced at the center of the liner on each side. Nipples screwed into the liners and projecting through the cylinder block and sealed thereto by packing glands carry the oil through the water jackets.

The lubricator is fully described in the Madison-Kipp bulletin attached at the end of the book. Oil feeds to the pistons should be adjusted to 20-25 drops per minute when the engine is new, but this may be reduced to approximately 15 to 20 drops per minute after the pistons and rings have been well worn in. **KEEP THE LUBRICATOR WELL FILLED WITH CLEAN OIL.** Use the same oil that is used in the engine. Do not under any circumstances allow it to run dry as serious damage to the pistons and liners may result. This should be made a regular part of the engine room routine and should never be neglected. The lubricator is mounted on a bracket on the manifold side of the engine, and is driven from an eccentric on the end of the camshaft. The eccentric is enclosed and is lubricated by a feed from the lubricator, but the exposed linkage should be hand oiled daily.

### 11. SPECIAL EQUIPMENT

On engines built to special government requirements modifications in the standard equipment as described in the preceding paragraphs have been made in order to meet these requirements. The most important changes affecting the lubricating oil coolers and filters are described in the following.

#### SPECIAL LUBRICATING OIL COOLER

Certain government specifications require a minimum size on the cooler tubing and also require that it should be possible to withdraw the tube bundle for cleaning. In this particular case the Ross type cooler is similar to the cooler described in paragraph 8 except that the tube bundle and the tube sheets are separate from the shell. On one end the tube sheet is clamped between the shell and the bonnet while on the other end the tube sheet is floating. The floating tube sheet is elongated and seal is affected by means of a gland and packing. To remove the bundle first loosen the bonnet on the floating end. Then remove the bonnet on the opposite end whereupon the tube bundle can then be withdrawn. Zinc plates are mounted in each of the two bonnets and the instructions in regard to the zincs given in paragraph 8 apply in this case also.

#### SPECIAL LUBRICATING OIL STRAINERS AND FILTERS

The lubricating oil strainer on special government engines is usually of the duplex type with switchover valve allowing either element to be cut out for service or cleaning. All strainers are of the metal element type similar to the one described in paragraph 9 and the instructions given in this paragraph in regard to cleaning apply in this case also.

A great variety of oil filters of the cartridge types are available and they may be arranged either as full flow or by-pass filters. In full flow filters the entire amount of oil is passed through whereas when the by-pass arrangement is used only 10% to 15% of the total amount of oil is passed through the filter. A typical by-pass filter manufactured by Briggs Clarifier Co. is described in the following.

The Briggs Clarifier filter is usually not attached to the engine but is mounted in some convenient location and piped to the engine lubricating oil system. Half inch piping should be used and the clarifier should be hooked up in accordance with information given on the outline drawing. The clarifier is provided with a four-way cock allowing it to be cut out for servicing. 1-1/2 to 2 ft. clearance should be allowed above the filter for easy removal of the cartridges. The filter cartridges should be changed when the oil begins to darken or when by chemical analysis the oil shows a precipitation number of more than .05 or a neutralization number of more than .3. These values are generally accepted as the limits for efficient engine operation. Since the Briggs clarifier acts as a by-pass filter a restriction orifice is built into the inlet connection in order to limit the flow through the filter to 10% to 15% of the total amount of oil circulated. Under no circumstances should the restriction orifice be removed from by-pass filters as this will rob the engine force feed lubricating system of too much oil and will lead to burned out bearings and insufficient lubrication in general.



MAINTENANCE & INSPECTION1. GENERAL RULES

Observing the following general rules will go a long way toward insuring satisfactory and trouble-free operation. Refer to preceding sections for detail instructions.

KEEP YOUR ENGINE CLEAN

Inspect the engine regularly and keep it wiped clean. If oil is left standing it quickly hardens and must be washed or scraped off. It is much easier to keep the engine clean than to get it clean, and there is always less trouble with a clean engine than with one that is covered with oil and dirt.

LEAVE WELL ENOUGH ALONE

When the engine is running satisfactorily and smoothly, do not continually try to better the operation with minor adjustments.

NEVER ALLOW YOUR ENGINE TO SMOKE

When the exhaust from an engine is smoky it clearly indicates that combustion is not perfect and that residue, in the shape of smoke, is clinging to the oily surfaces of the cylinders, pistons, piston rings, valves, etc. When this happens you are creating trouble for yourself and doing an injustice to the engine. Therefore, the first thing in consideration of the operation of a Diesel engine is: DO NOT ALLOW YOUR ENGINE TO SMOKE

KEEP A COMPLETE LOG OF ENGINE OPERATION

A complete log should always be kept of the engine operation, and back sheets should be consulted frequently and compared with present conditions. In this way gradual changes can be detected and investigated and insignificant troubles corrected before becoming real ones. Any unusual noises or other irregularities should be logged so that they will be investigated at the regular routine inspections.

INSPECTING REPAIRS

At completion of any adjustment or repair job, always make a thorough inspection to see that all parts have been correctly replaced, that bolts and nuts are tight, and that all cotter pins and locking wires are in place. If work involved rotating parts, bar engine around at least two full revolutions (so that camshaft is turned one revolution) to be sure that all parts are clear. Be sure that no tools or rags are left inside the engine.

2. SMOKY EXHAUST

Dark smoky exhaust usually occurs when the engine is loaded up (3/4 to full load) and indicates defective combustion which is usually due to one of the following causes:

- (a) Excessive carbon on spray valve tips.
- (b) Leaking spray valve.
- (c) Leaky exhaust, inlet, or air starting valves.
- (d) Buffer springs may be incorrectly adjusted.
- (e) Fuel cam or roller may be worn.
- (f) Leaky or stuck piston rings.
- (g) Uneven cylinder load balance.

If the dark exhaust smoke is not even but occurs in the form of puffs it is likely that the combustion is defective in one or two cylinders only. Where the trouble lies can usually be determined by cutting out spray valves one at a time. When this is done however, the engine should not carry more than about 3/4 load or the remaining cylinders will be overloaded.

Sometimes the exhaust smoke is lighter and may be termed blueish-white in color. When viewed against a clear sky, it resembles the appearance of steam but is usually



## Section Z

a little more blueish in color. Blueish-white exhaust smoke generally occurs during prolonged idling or when the engine is loaded up after a period of idling. This type of exhaust smoke consists primarily of vaporized or partially burnt fuel and is due to misfiring in one or more cylinders. Inspection of the exhaust manifold or muffler in this case generally shows the internal surfaces to be wetted by fuel and in extreme cases pools of fuel may be formed in these parts.

Blueish-white exhaust smoke, unless it is dense, is generally not harmful to the engine, and as a rule practically all of the vaporized fuel is ejected with the exhaust gases. The unburnt fuel may however mix with soot and other products of combustion and in time cause sticking of piston rings and exhaust valves. In extreme cases where long periods of idling and long periods of heavy loading occur alternately, exhaust passages, manifold and muffler may gradually become partially plugged and the areas restricted to a point where the engine operation is affected.

The remedy for this type of exhaust smoke is to make sure that the engine fires on all cylinders when idling or at low loads. Which particular cylinders are misfiring can generally be determined by feeling the exhaust elbows. This should be done carefully however to avoid burning the hands on those that are hot. The fuel injection pressure should be reduced when idling to about 2200 to 2500 lbs. per square inch as this tends to lengthen out the injection periods and prevent misfiring. The injection timing should also be checked in accordance with paragraph 17 in Section O. In extreme cases, it may be necessary to balance the engine for equal loading on cylinders at idling or low load instead of at full load (See paragraph 18, Section O).

### 3. INSPECTION AND MAINTENANCE ROUTINE

The following routine for regular inspection and maintenance work is suggested as a guide for the operator, but experience with the engine over a period of time may indicate changes that should be made in the schedule.

It will be noted in the following schedules that spray valve cleaning has not been included. It is believed the spray valves should be cleaned only when necessary, rather than at definite intervals. The necessity for cleaning will be indicated by increased or uneven exhaust temperatures or smoky exhaust and at either of these indications the spray valves should be inspected and cleaned, if necessary.

In the following, work to be done under each routine should include work listed under preceding routines. For example, work under "Annual Routine" includes everything listed under all other routines.

#### 8-HOUR ROUTINE

(a) Hand oil the following points:

1. The inlet and exhaust valve stems.
2. The rocker arms at their fulcrums and at their push rod ends.
3. Inlet and exhaust lifters, fuel wedges, lifter and buffers.
4. Wedge shaft bearings.
5. Mechanical lubricator lineage.

If the inlet and exhaust valves are sluggish in action it is preferable to use penetrating oil on the stems. If this is not available a mixture of equal parts of engine lubricating oil and kerosene may be used. (A mixture of two-thirds engine fuel oil and one-third lubricating oil can be used in an emergency.) For all other points in above schedule use engine lubricating oil.

- (b) Every four hours check the oil level in the mechanical lubricator. Check oil level in sump or day tank. Fill with clean engine oil when necessary. If engine is equipped with sump tank check the oil level and add oil if necessary.
- (c) Turn the handle of the lubricating oil and fuel strainers. Always turn cleaning handles immediately after stopping the engine.
- (d) Take readings of all indicating instruments such as gages, thermometers, etc.

#### DAILY OR 24-HOUR ROUTINE

- (a) Clean out the sump tanks of the lubricating oil and fuel oil filters.
- (b) Check the feeds of the mechanical lubricator.



200 TO 300-HOUR ROUTINE

- (a) Check intake and exhaust valve timing.
- (b) Check spray valve timing. (After starting engine check cylinder load balance.) (See Section O)
- (c) Clean out lubricating oil day tank or sump tank if lubricating oil is dirty or dark in color.
- (d) Remove crankcase doors and inspect connecting rods. Be sure that all connecting rod bolts are tight and that everything is in order. Inspect lower part of cylinder liner bore.
- (e) On engines equipped with cartridge type filters these may or may not need replacement. The time between replacements will vary with the type of fuel or lubricating oil used and with the operating conditions to which the engine is subjected. When the lubricating oil turns black rapidly following an oil change, the cartridges should be replaced.
- (f) Inspect zincs in oil and water coolers. Replace if necessary.

SEMI-ANNUAL ROUTINE

- (a) Pull cylinder heads and pistons, remove rings and clean pistons and grooves thoroughly. Check rings for side and end clearance.
- (b) Examine cylinder liner walls. Watch for shoulders due to ring travel.
- (c) Grind intake and exhaust valves. Check valve springs for length and tension and for defects.
- (d) Recondition spray valves. Inspect stem packing and repack if necessary. Inspect stem for wear and replace if worn. Inspect and clean spray valve tips. Grind stem to tip.
- (e) Inspect main and connecting rod bearings. Check clearances and inspect bearing surfaces. Adjust clearances if necessary.
- (f) Inspect gear train carefully, observing backlash, indications of wear on teeth, and clearance on intermediate gear bearings.
- (g) Inspect camshaft assembly. Watch for worn or loose cams, loose or worn rollers or pins on the lifters. Be sure all keys and lock bolts are in place and tight.
- (h) Disassemble lubricating oil cooler and inspect for corrosion. Clean thoroughly before reassembling. Renew zinc plugs if necessary.
- (i) Check flywheel and coupling bolts. Tighten up if necessary.
- (j) Check all hold-down bolts between engine and foundation. If they are loose check the engine alignment.

ANNUAL ROUTINE

- (a) Check crankshaft alignment. If shaft needs realignment it is recommended that work be done by an experienced and careful mechanic.
- (b) Examine cylinder jackets and exhaust manifold water jackets. If scale is over 1/16" thick it should be removed by scale remover solution.
- (c) Remove and inspect lubricating oil and fuel oil transfer pumps. Note conditions of bearings, shafts and seals. Replace if necessary.
- (d) Inspect all starting air valves and grind if necessary.
- (e) Remove top cover and mounting plate on high pressure fuel pump. Note condition of pump plungers and barrels. Disassemble crossheads and connecting rods and inspect for wear. Inspect suction and discharge valves and grind seats. Check valve lifts.
- (f) Inspect governor and all moving parts for wear and signs of distress. Inspect entire linkage between governor and wedge shaft for lost motion and wear. Fuel wedges, links and pins should also be inspected for wear and



## Section Z

replaced if necessary.

- (g) Inspect Mechanical Lubricator and connections to cylinder liners. Inspect ratchet mechanism for wear and proper functioning. Hand crank lubricator and observe the feed to each liner. Watch for water leaks at the nipples going through the water jackets.
- (h) Clean out crankcase thoroughly. Be sure that all cleaning solution is drained out after cleaning is completed.